

# JVC



English

## MICRO COMPONENT SYSTEM

微型组合音响

ระบบไมโครคอมโพเนนท์

中文

**UX-J66V**— Consists of CA-UXJ66V and SP-UXJ66V  
由CA-UXJ66V及CA-UXJ66V组成

ประกอบด้วย CA-UXJ66V และ SP-UXJ66V

**UX-J55V**— Consists of CA-UXJ55V and SP-UXJ55V  
由CA-UXJ55V及CA-UXJ55V组成

ประกอบด้วย CA-UXJ66V และ SP-UXJ66V

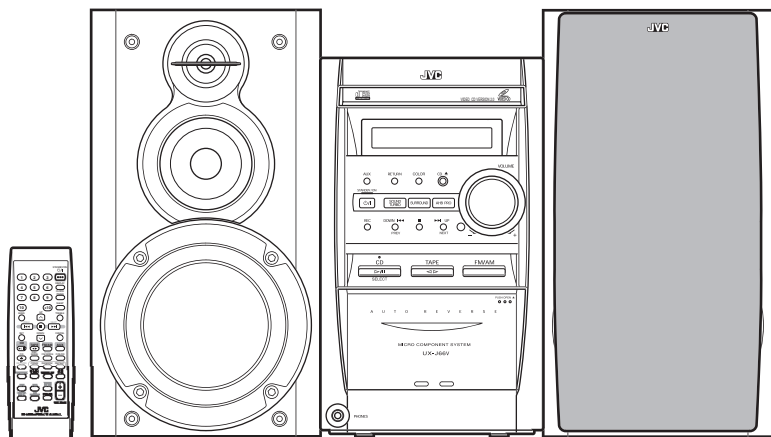

SP-UXJ66V

CA-UXJ66V

SP-UXJ66V

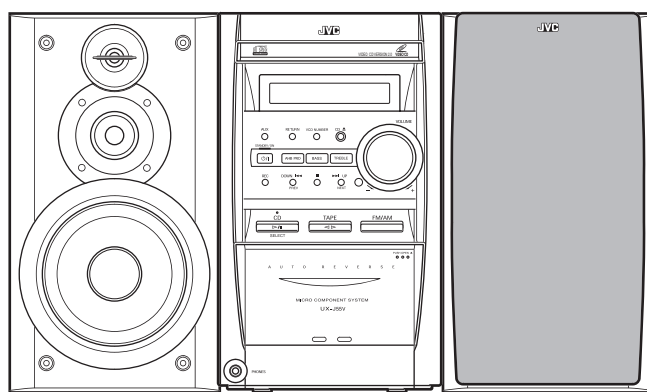

SP-UXJ55V

CA-UXJ55V

SP-UXJ55V

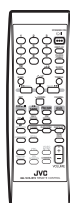

### INSTRUCTIONS

使用说明书

คำแนะนำ

**For Customer Use:**

Enter below the Model No. and Serial No. which are located either on the rear, bottom or side of the cabinet. Retain this information for future reference.

Model No. \_\_\_\_\_

Serial No. \_\_\_\_\_

ภาษาไทย

# Warnings, Cautions and Others

## 警告，注意及其他须知事项

### คำเตือน ข้อควรระวัง และอื่นๆ

#### Caution — **⏻/ I STANDBY/ON button!**

Disconnect the mains plug to shut the power off completely (the **⏻/ I STANDBY/ON** lamp goes off).  
The **STANDBY/ON** button in any position does not disconnect the mains line.

- When the unit is on standby, the **STANDBY/ON** lamp lights red.
- When the unit is turned on, the **STANDBY/ON** lamp lights green.

The power can be remote controlled.

#### 注意 — **⏻/ I STANDBY/ON 开关！**

无论**⏻/ I STANDBY/ON** 开关在任何位置，电源线的电源还是没有被切断，  
若要将电源完全关闭，应把电源插头拔离插座  
(**STANDBY/ON** 灯熄灭)。

- 当主机正处于备用状态，**STANDBY/ON** 灯为红色。
- 当主机开启后，**STANDBY/ON** 灯为青色。

电源开关可用遥控器控制。

#### ข้อควรระวัง ปุ่ม **⏻/ I STANDBY/ON!**

ดึงปลั๊กหลักออกเพื่อปิดเครื่องอย่างถูกต้อง (ไฟสัญญาณพร้อมทำงาน/เปิดดับ) **⏻/ I STANDBY/ON** ปุ่มพร้อมทำงาน/  
เปิดในตำแหน่งใดๆ ก็ตามจะไม่สามารถตัดการเชื่อมต่อสายไฟหลักได้

- เมื่ออุปกรณ์อยู่ในสภาพพร้อมทำงาน ไฟสัญญาณพร้อมทำงาน/เปิดจะเป็นสีแดง
- เมื่อเปิดอุปกรณ์ ไฟสัญญาณพร้อมทำงาน/เปิดจะเป็นสีเขียว

ท่านสามารถเปิดปิดโดยใช้รีโมทคอนโทรล

#### CAUTION

To reduce the risk of electrical shocks, fire, etc.:

1. Do not remove screws, covers or cabinet.
2. Do not expose this appliance to rain or moisture.

#### 警告

为了防止触电，火灾等危险：

1. 请勿擅自卸下螺丝钉，盖子或机壳。
2. 切勿让本机受雨淋或置于潮湿环境中。

#### ข้อควรระวัง

เพื่อเลี่ยงการถูกไฟฟ้าดูด ไฟไหม้ ฯลฯ:

1. ห้ามถอดน็อต ฝา หรือโครงเครื่องออกมา
2. อย่าให้อุปกรณ์นี้ถูกฝนหรือความชื้น

#### CAUTION

- Do not block the ventilation openings or holes.  
(If the ventilation openings or holes are blocked by a newspaper or cloth, etc., the heat may not be able to get out.)
- Do not place any naked flame sources, such as lighted candles, on the apparatus.
- When discarding batteries, environmental problems must be considered and local rules or laws governing the disposal of these batteries must be followed strictly.
- Do not expose this apparatus to rain, moisture, dripping or splashing and that no objects filled with liquids, such as vases, shall be placed on the apparatus.

#### 注意

- 请勿堵塞通风口或通风孔。  
(如果通风口或通风孔被报纸或布等堵塞，热量将无法散出。)
- 请勿在本设备上放置任何裸露的火源，如点燃的蜡烛。
- 处理废弃电池时，必须考虑环境问题，并严格遵守当地关于处理废弃电池的有关法律或规定。
- 切勿将本装置暴露于雨水所及，潮湿，滴水或易于溅起水花的地方，亦不要将任何装满液体的物件（如花瓶）放置在本装置上。

#### ข้อควรระวัง

- อย่าให้มีสิ่งกีดขวางช่องเปิดหรือระบายอากาศ  
(หากช่องเปิดหรือระบายอากาศมีกระดาษหนังสือพิมพ์หรือผ้า ฯลฯ วางทับอยู่ ความร้อนอาจไม่สามารถระบายออกไปได้)
- ห้ามวางไฟซึ่งไม่มีที่กำบังไว้บนอุปกรณ์ เช่นเทียนที่จุดแล้ว
- ในการกำจัดแบตเตอรี่ที่ไม่ใช้แล้วจะต้องคำนึงถึงปัญหาด้านสิ่งแวดล้อม และต้องทำตามระเบียบหรือกฎหมายเกี่ยวกับการกำจัดแบตเตอรี่ในประเทศของท่านอย่างเคร่งครัด
- ห้ามให้อุปกรณ์นี้ในห้องน้ำหรือในที่เปียกชื้น รวมทั้งห้ามวางภาชนะที่มีน้ำหรือของเหลวบรรจุอยู่ (เช่น เครื่องสำอาง แจกันดอกไม้ กระถางต้นไม้ ฯลฯ) ไว้บนอุปกรณ์

# IMPORTANT FOR LASER PRODUCTS

鐳射产品的重要说明

## มีความสำคัญสำหรับผลิตภัณฑ์เลเซอร์

REPRODUCTION OF LABELS / 标签内容说明 / การทำสำเนาแผ่นฉลาก

WARNING LABEL, PLACED INSIDE THE UNIT

警告标签，贴于机内

ป้ายเตือนติดไว้ภายในอุปกรณ์

<b>CAUTION:</b> Invisible laser radiation when open and interlock failed or defeated. AVOID DIRECT EXPOSURE TO BEAM. (e)	<b>ADVARSEL:</b> Usynlig laserstråling ved åbning, når sikkerhedsafbrydere er ude af funktion. Undgå udsættelse for stråling (d)	<b>WARNING:</b> Osynlig laserstråling når denna del är öppnad och spärren är urkopplad. Beträkta ej strålen. (s)	<b>VARO:</b> Avattaessa ja suojalukitus ohitettaessa olet alttiina näkymättömälle lasersäteilylle. Älä katso säteeseen. (f)
--	--	--	---

1. CLASS 1 LASER PRODUCT
2. **CAUTION:** Invisible laser radiation when open and interlock failed or defeated. Avoid direct exposure to beam.
3. **CAUTION:** Do not open the top cover. There are no user serviceable parts inside the Unit; leave all servicing to qualified service personnel.

1. 一级鐳射产品
2. **危险：**当内部锁定装置失效或者损坏后，打开盖板可能会产生不见的鐳射辐射。应避免受到光束直接照射。
3. **注意：**请勿打开顶盖板，本机内部没有用户可自行维修的部件；所有维修工作应由有资格的人员完成。

1. ผลิตภัณฑ์เลเซอร์ประเภท 1
2. ข้อควรระวัง: เมื่อเปิดเครื่องและอุปกรณ์อินเทอร์ล็อกไม่ทำงานหรือล้มเหลว ต้องระวังรังสีเลเซอร์ซึ่งมองไม่เห็น และควรหลีกเลี่ยงการถูกแสงตรงๆ
3. ข้อควรระวัง: ห้ามเปิดฝาด้านบน ภายในอุปกรณ์นี้ไม่มีชิ้นส่วนใดที่ผู้ใช้สามารถซ่อมแซมได้ด้วยตัวเอง ควรให้เจ้าหน้าที่ผู้เชี่ยวชาญเป็นผู้ซ่อมแซมเท่านั้น

### Caution: Proper Ventilation

To avoid risk of electric shock and fire, and to prevent damage, locate the apparatus as follows:

1 Front:

No obstructions and open spacing.

2 Sides/ Top/ Back:

No obstructions should be placed in the areas shown by the dimensions below.

3 Bottom:

Place on the level surface. Maintain an adequate air path for ventilation by placing on a stand with a height of 10 cm or more.

### 注意：正确通风

为避免发生触电和火警的危险，及防止本机受损，请将本机如下放置：

1. 前面： 没有障碍物及地方开阔。
2. 侧面 / 顶面 / 背面： 在图中所示范围中，不应放置任何障碍物。
3. 底部： 放置在水平面上。放置在一个高 10 厘米或以上的台面上，以保持足够的通风道。

### ข้อควรระวัง: การระบายอากาศที่เหมาะสม

เพื่อเลี่ยงการถูกไฟฟ้าดูดและไฟไหม้ รวมทั้งเพื่อป้องกันความเสียหายที่อาจเกิดขึ้นได้ ควรติดตั้งอุปกรณ์ตามคำแนะนำต่อไปนี้:

1. ด้านหน้า: มีที่ว่างเพียงพอและไม่สิ่งกีดขวาง
2. ด้านข้าง/ด้านบน/ด้านหลัง: ไม่ให้มีสิ่งกีดขวางในระยะที่แสดงไว้ด้านล่างนี้
3. ด้านล่าง: วางบนพื้นผิวที่เรียบเสมอกัน และให้มีที่ว่างสำหรับการระบายอากาศโดยวางบนชั้นที่สูงจากพื้น 10 ซม. หรือมากกว่า

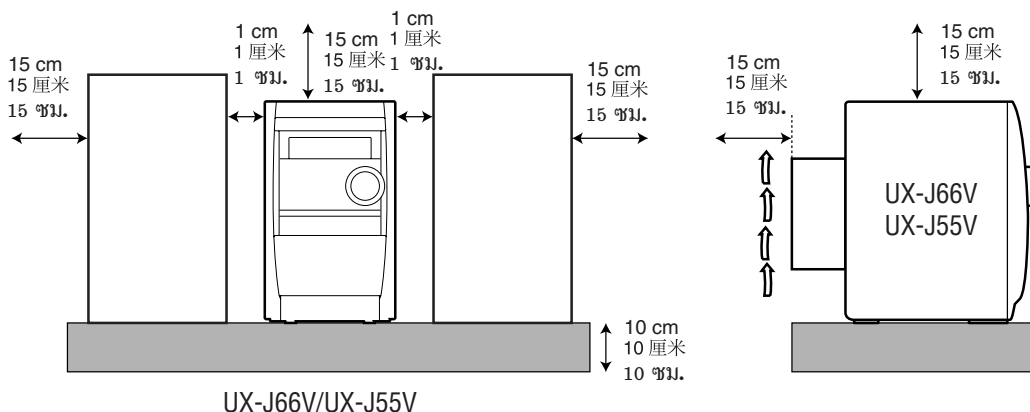

# Introduction

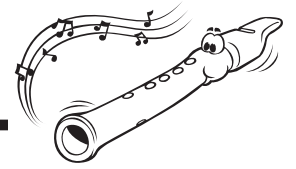

We would like to thank you for purchasing one of our JVC products. Before operating this unit, read this manual carefully and thoroughly to obtain the best possible performance from your unit, and retain this manual for future reference.

## About This Manual

This manual is organized as follows:

- **The manual mainly explains operations using the buttons on the remote control.**  
You can use the buttons both on the remote control and on the main unit for the same operations if they have the same or similar names (or marks), unless mentioned otherwise.  
The illustrations used in this manual are of UX-J66V unless mentioned otherwise.
- Basic and common information that is the same for many functions is grouped in one place, and is not repeated for each procedure. For instance, we do not repeat the information about turning on/off the unit, setting the volume, changing the sound effects, and others, which are explained in the section “Common Operations” on pages 9 to 11.
- The following symbols are used in this manual:



Gives you warning and caution to prevent damage or risk of fire/electric shock. Furthermore, it gives you information about what is not good for obtaining the best possible performance from the unit.



Gives you information and hints you should know.

## Precautions

### Installation

- Install in a place which is level, dry and neither too hot nor too cold—between 5°C and 35°C.
- Install the unit in a location with adequate ventilation to prevent internal heat buildup in the unit.
- Leave sufficient distance between the unit and the TV.
- Keep the speakers away from the TV to avoid interference with TV.



DO NOT install the unit in a location near heat sources, or in a place subject to direct sunlight, excessive dust or vibration.

### Power sources

- When unplugging the unit from the wall outlet, always pull on the plug, not the AC power cord.



DO NOT handle the AC power cord with wet hands.

### Moisture condensation

Moisture may condense on the lens inside the unit in the following cases:

- After starting heating in the room
  - In a damp room
  - If the unit is brought directly from a cold to a warm place
- Should condensation occur, the unit may malfunction. In this case, leave the unit turned on for a few hours until the moisture evaporates, unplug the AC power cord, then plug it in again.

### Others

- Should any metallic object or liquid fall into the unit, unplug the power cord and consult your dealer before operating any further.
- If you are not going to operate the unit for an extended period of time, unplug the AC power cord from the wall outlet.



DO NOT disassemble the unit since there are no user serviceable parts inside.

If anything goes wrong, unplug the AC power cord and consult your dealer.

### Which compact discs can be used?

Many types of compact discs are sold for a variety of uses. The player can play the following compact discs:

#### Video CD discs both with and without PBC



#### Audio CD discs



#### Discs you cannot playback

Any other discs than listed above (such as CD-ROM, DVD, CD-G or CD-I Discs) cannot be played. Playing back such discs may generate noise and damage your speakers. Even though a logo listed above is printed on the disc, it may not be played if it is a non-standard disc.

# Contents

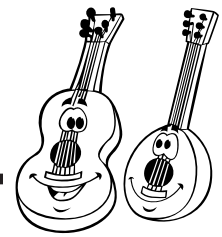

<b>Location of the Buttons and Controls</b> .....	<b>3</b>	<b>Using the Video CD Player (Video CDs)</b> .....	<b>19</b>
Front Panel and Top View .....	3	Setting the TV System .....	19
Remote Control .....	5	Playing Video CDs with the PBC Function .....	19
<b>Getting Started</b> .....	<b>6</b>	Playing Video CDs with the PBC Function without Using the Menu Screen (Continuous Play) .....	19
Supplied Accessories .....	6	Playing Video CDs with the PBC Function Using the Menu Screen (Menu-Driven Play) .....	20
Putting the Batteries into the Remote Control .....	6	Playing video CDs without the PBC Function .....	21
Connecting Antennas .....	6	Various Functions to Enhance Your Enjoyment .....	21
Connecting Speakers .....	7	<b>Playing Back Tapes</b> .....	<b>23</b>
Connecting Other Equipment .....	8	Playing Back a Tape .....	23
Adjusting the Voltage Selector .....	8	<b>Recording</b> .....	<b>24</b>
<b>Common Operations</b> .....	<b>9</b>	Recording on a Tape .....	24
Setting the Clock .....	9	Disc Direct Recording .....	25
Setting the AM Tuner Interval Spacing .....	9	One Track Recording .....	25
Turning On the Power .....	10	<b>Using the Microphone and Multiplex CDs</b> .....	<b>26</b>
Adjusting the Volume .....	10	Singing Along – Karaoke .....	26
Enjoying Sound Effects .....	10	Microphone Mixing .....	26
Selecting the Illumination Brightness .....	11	To Record Microphone Mixing on a Tape .....	27
Selecting the Display Color (ONLY FOR UX-J66V) .....	11	Using the Multiplex CDs and Singing Along with Multiplex (MPX) Karaoke CDs .....	27
<b>Listening to FM and AM Broadcasts</b> .....	<b>12</b>	<b>Using the Timers</b> .....	<b>28</b>
Tuning in to a Station .....	12	Using Daily Timer and Recording Timer .....	28
Presetting Stations .....	12	Using Sleep Timer .....	29
Tuning in to a Preset Station .....	13	<b>Maintenance</b> .....	<b>30</b>
<b>Disc Introduction</b> .....	<b>14</b>	<b>Troubleshooting</b> .....	<b>31</b>
<b>Playing Back Discs (CD/CD-R/CD-RW/MP3)</b> .....	<b>15</b>	<b>Specifications</b> .....	<b>32</b>
Playing Back the Entire Disc—Normal Play .....	15		
Basic Disc Operations .....	16		
Programming the Playing Order of the Tracks —Program Play .....	17		
Playing at Random—Random Play .....	17		
Repeating Tracks—Repeat Play .....	18		
Prohibiting Disc Ejection—Tray Lock .....	18		

# Location of the Buttons and Control

Become familiar with the buttons and control on your unit.

## Front Panel and Top View

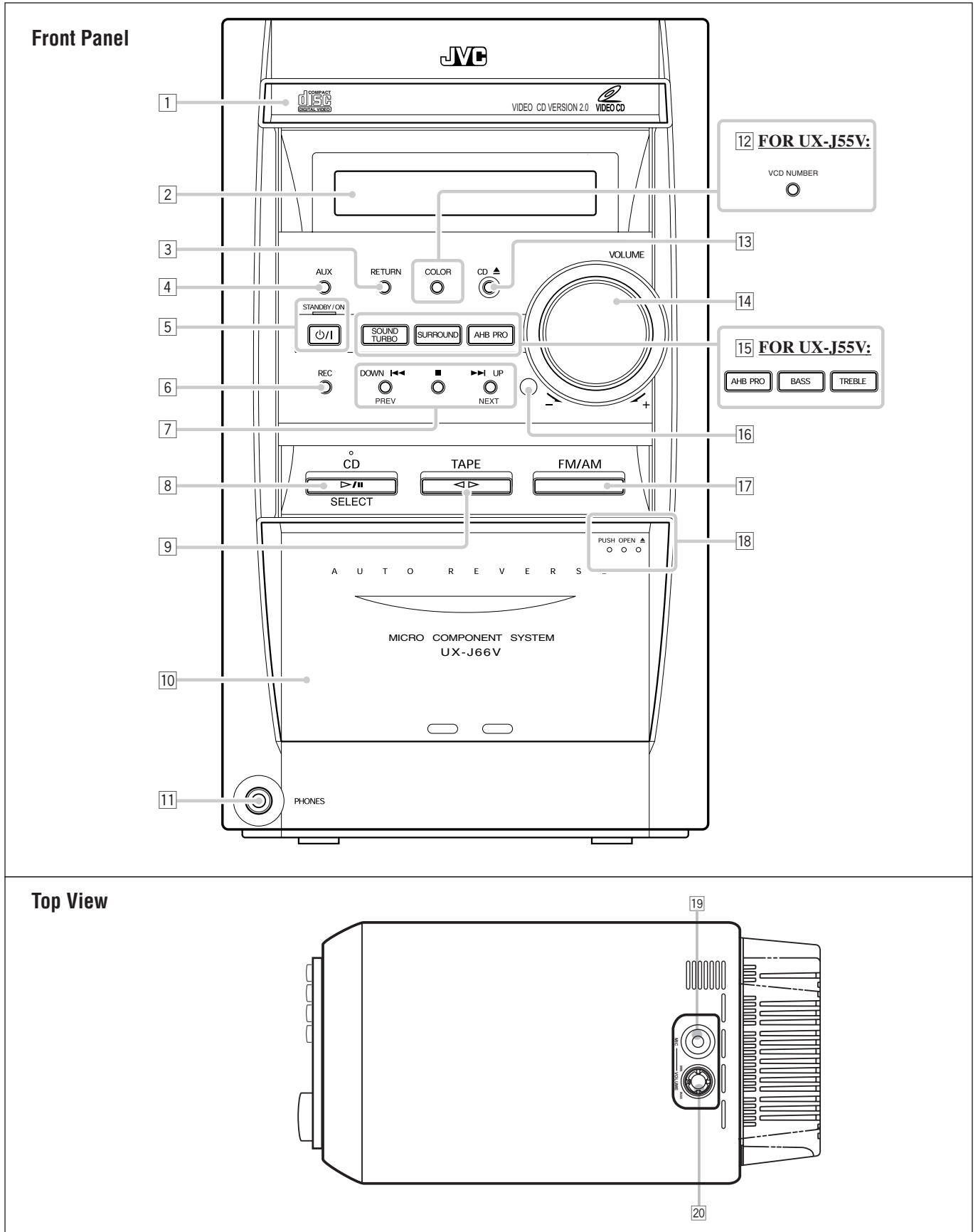

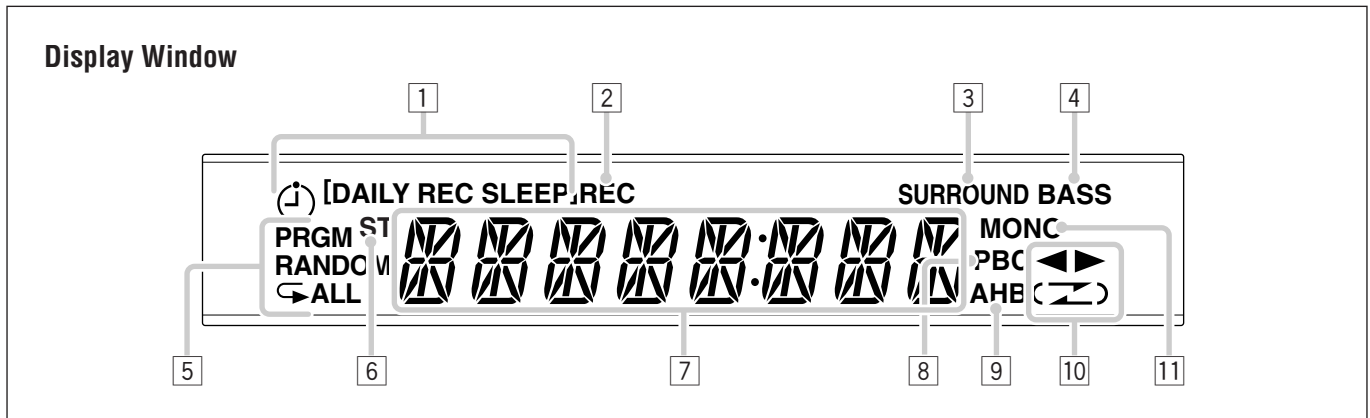

See the pages in parentheses for details.

### Front Panel

- 1 Disc tray
- 2 Display window
- 3 RETURN button (20 – 21)
- 4 AUX button (10)  
*Pressing this button also turns on the unit.*
- 5 STANDBY/ON  $\odot/\text{I}$  button and STANDBY/ON lamp (10, 29)
- 6 REC (recording) button (24)
- 7 Multi operation buttons
  - DOWN  $\blacktriangleleft$  (reverse skip)/PREV,  $\blacksquare$  (stop) and UP  $\blacktriangleright$  (forward skip)/NEXT
- 8 SELECT CD  $\triangleright/\text{II}$  (play/pause) button (16, 18)  
*Pressing this button also turns on the unit.*
- 9 TAPE  $\triangleleft/\triangleright$  button (10)  
*Pressing this button also turns on the unit.*
- 10 Cassette holder
- 11 PHONES jack (10)
- 12 FOR UX-J66V:  
COLOR button (11)
- FOR UX-J55V:  
VCD NUMBER button (20, 22)
- 13 CD  $\blacktriangle$  (disc tray open/close) button (15, 16)  
*Pressing this button also turns on the unit.*
- 14 VOLUME + / - control (10)
- 15 FOR UX-J66V:  
SOUND TURBO button (11)  
SURROUND button (11)  
AHB (Active Hyper Bass) PRO button (10)
- FOR UX-J55V:  
AHB (Active Hyper Bass) PRO button (10)  
BASS button (10)  
TREBLE button (10)
- 16 Remote sensor
- 17 FM/AM button (9, 12)  
*Pressing this button also turns on the unit.*
- 18 PUSH OPEN  $\blacktriangle$  (cassette holder open) portion (23, 24)
- 19 MIC Jack (26, 27)
- 20 MIC VOLUME Control (26, 27)

### Display Window

- 1 Timer indicators
  - $\odot$  (timer), DAILY, REC (recording timer), and SLEEP
- 2 REC (recording) indicator
- 3 ONLY FOR UX-J66V:  
SURROUND indicator
- 4 ONLY FOR UX-J66V:  
BASS indicator
- 5 Disc play mode indicators
  - PRGM (program), RANDOM, and  $\curvearrowright$  ALL (repeat)
- 6 ST (stereo) indicator
- 7 Main display
  - Shows the source name, frequency, etc.
- 8 PBC (Playback Control) indicator
- 9 AHB (Active Hyper Bass pro) indicator
- 10 Tape operation indicators
  - $\blacktriangleleft$  (tape direction) and  $\curvearrowright$  (reverse mode)
- 11 MONO indicator

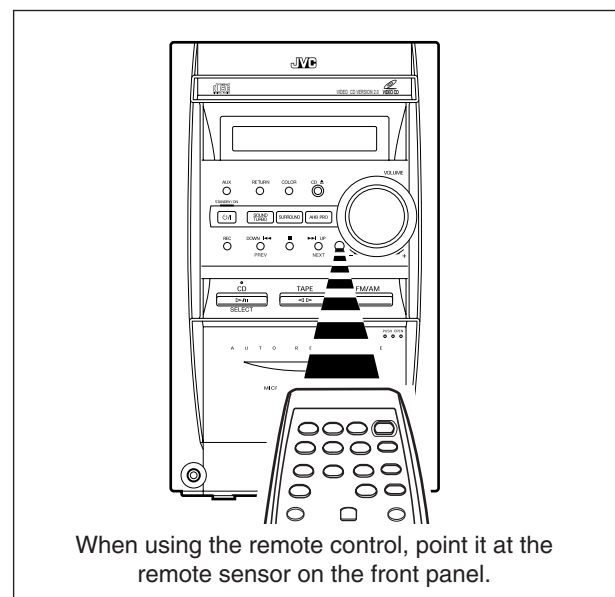



## Remote Control

### For UX-J66V

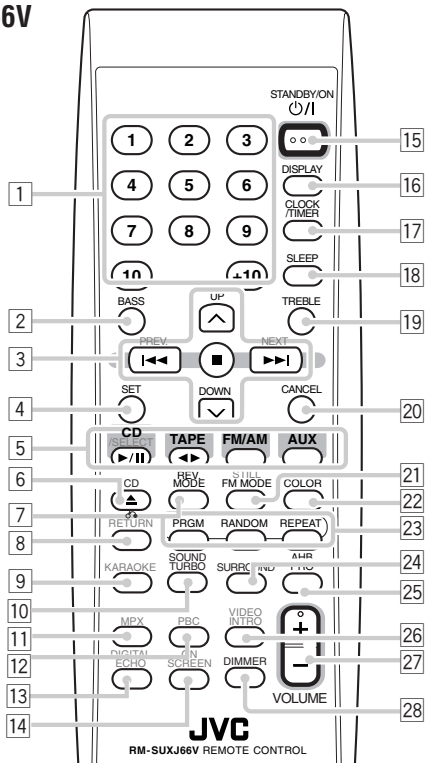

- 1 Number buttons
- 2 BASS button (10)
- 3 Multi operation buttons
  - ^ UP, ◀◀ PREV (reverse skip), ■ (stop), ▶▶ NEXT (forward skip) and ∨ DOWN
- 4 SET button (12, 17)
- 5 Source buttons
  - ▶/|| CD/SELECT, ◀▶ TAPE, FM/AM and AUX
 Pressing one of these buttons also turns on the unit.
- 6 CD ▲ (disc tray open/close) button (15, 16)  
Pressing this button also turns on the unit.
- 7 REV.MODE (reverse mode) button (23 – 24)
- 8 ♂ RETURN button (20, 21)
- 9 KARAOKE button (26)
- 10 SOUND TURBO button (11)
- 11 MPX button (27)
- 12 PBC button (20)
- 13 DIGITAL ECHO button (26, 27)
- 14 ON SCREEN button (22)
- 15 STANDBY/ON ⏻/⏻ button (10, 29)
- 16 DISPLAY button (9)
- 17 CLOCK/TIMER button (9, 28, 29)
- 18 SLEEP button (29)
- 19 TREBLE button (10)
- 20 CANCEL button (17)
- 21 STILL/FM MODE button (12, 21)
- 22 COLOR button (11)
- 23 Disc play mode buttons (17, 18)
  - PRGM (program), RANDOM, and REPEAT
- 24 SURROUND button (11)
- 25 AHB (Active Hyper Bass) PRO button (10)
- 26 VIDEO INTRO button (22)
- 27 VOLUME + / - button (10)
- 28 DIMMER button (11)

### For UX-J55V

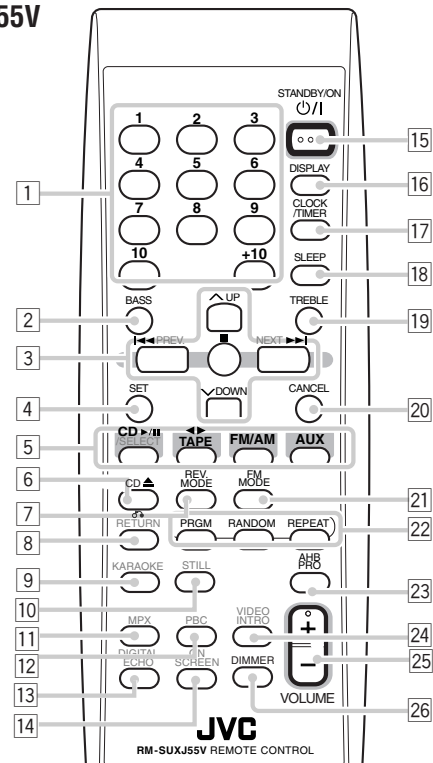

- 1 Number buttons
- 2 BASS button (10)
- 3 Multi operation buttons
  - ^ UP, PREV ◀◀ (reverse skip), ■ (stop), ▶▶ NEXT (forward skip) and ∨ DOWN
- 4 SET button (12, 17)
- 5 Source buttons
  - ▶/|| CD/SELECT, ◀▶ TAPE, FM/AM and AUX
 Pressing one of these buttons also turns on the unit.
- 6 CD ▲ (disc tray open/close) button (15, 16)  
Pressing this button also turns on the unit.
- 7 REV.MODE (reverse mode) button (23 – 24)
- 8 ♂ RETURN button (20, 21)
- 9 KARAOKE button (26)
- 10 STILL button (21)
- 11 MPX button (27)
- 12 PBC button (20)
- 13 DIGITAL ECHO button (26, 27)
- 14 ON SCREEN button (22)
- 15 STANDBY/ON ⏻/⏻ button (10, 29)
- 16 DISPLAY button (9)
- 17 CLOCK/TIMER button (9, 28, 29)
- 18 SLEEP button (29)
- 19 TREBLE button (10)
- 20 CANCEL button (17)
- 21 FM MODE button (12)
- 22 Disc play mode buttons (17, 18)
  - PRGM (program), RANDOM, and REPEAT
- 23 AHB (Active Hyper Bass) PRO button (10)
- 24 VIDEO INTRO button (22)
- 25 VOLUME + / - button (10)
- 26 DIMMER button (11)



## Supplied Accessories

Make sure that you have all the following items. The number in parentheses indicates the quantity of each piece supplied.

- AM loop antenna (1)
- FM antenna (1)
- Remote control (1)
- Batteries (2)
- Speaker cords (ONLY FOR UX-J66V) (4)
- Video cord (1)
- AC plug adaptor (1)

If anything is missing, consult your dealer immediately.

## Putting the Batteries into the Remote Control

Insert the batteries—R6(SUM-3)/AA(15F)—into the remote control, by matching the polarity (+ and –) on the batteries with the + and – markings on the battery compartment.

When the remote control can no longer operate the unit, replace both batteries at the same time.

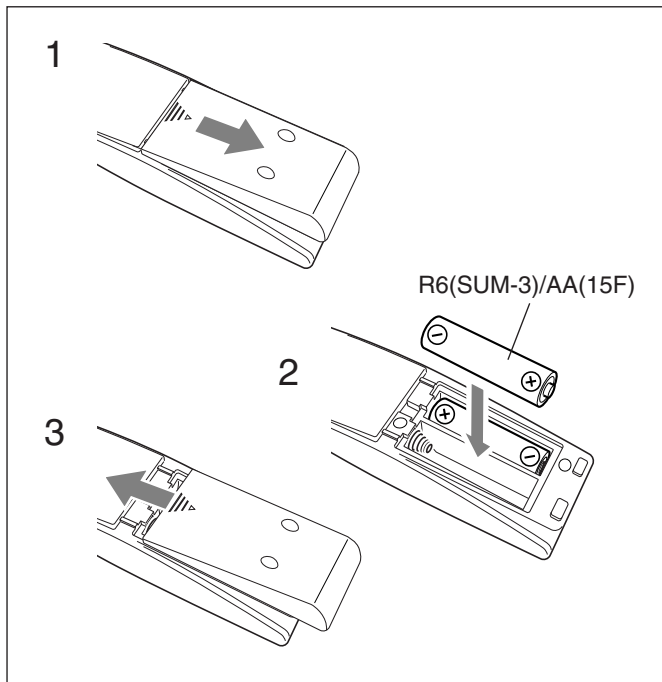

- DO NOT use an old battery together with a new one.
- DO NOT use different types of batteries together.
- DO NOT expose batteries to heat or flame.
- DO NOT leave the batteries in the battery compartment when you are not going to use the remote control for an extended period of time. Otherwise, the remote control will be damaged from battery leakage.

## Connecting Antennas

### FM antenna

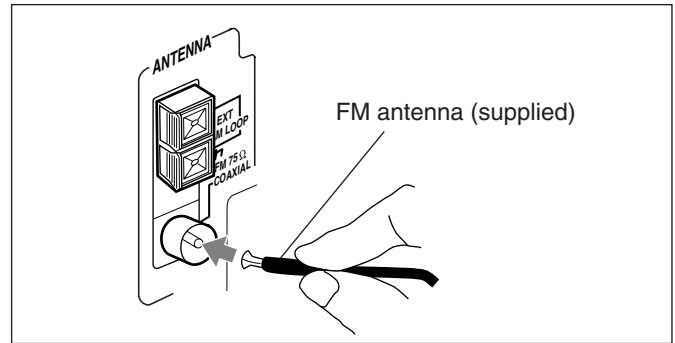

- 1 **Attach the FM antenna to the FM 75 Ω COAXIAL terminal.**
- 2 **Extend the FM antenna.**
- 3 **Fasten it up in the position which gives you the best reception, then fix it on the wall, etc.**



#### About the supplied FM antenna

The FM antenna supplied with this unit can be used as temporary measure. If reception is poor, you can connect an outdoor FM antenna.

#### To connect an outdoor FM antenna

Before connecting the antenna, disconnect the supplied FM antenna.

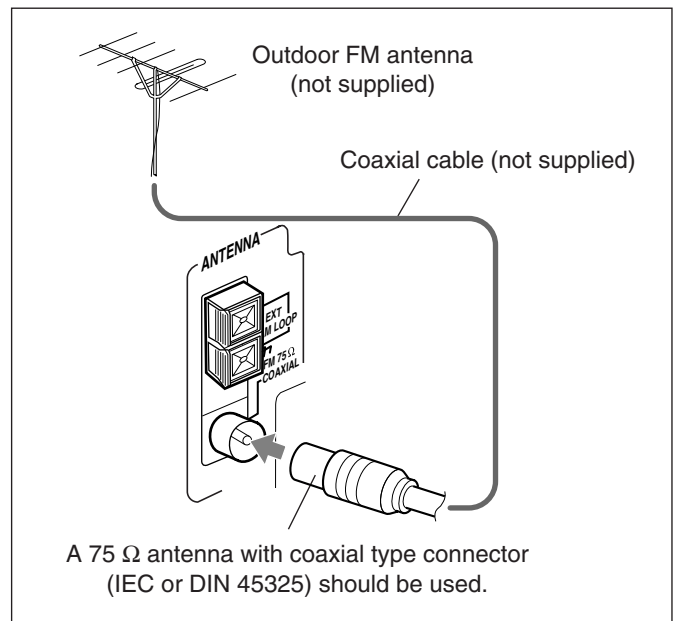

## AM antenna

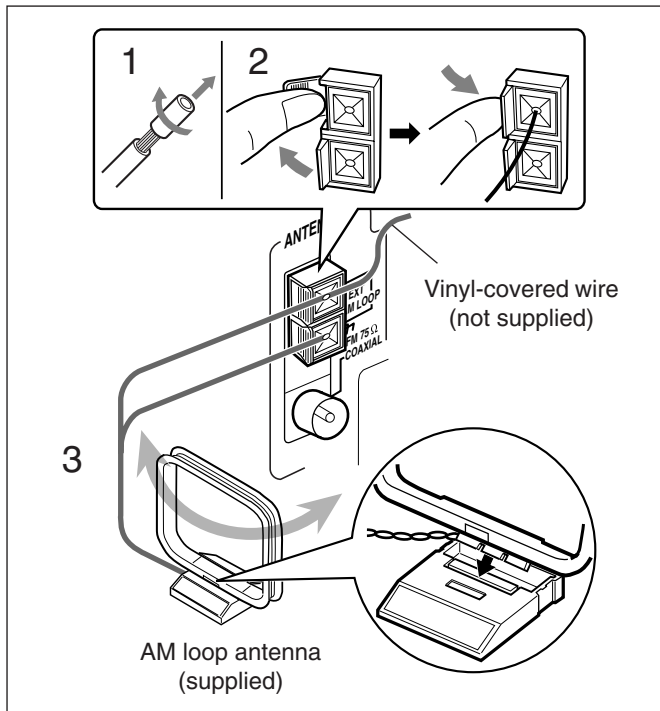

- 1 If the cords are covered with insulation, remove a short section of insulation at the end of each cord by twisting and pulling it off.
- 2 Connect the AM loop antenna to the AM LOOP terminals as illustrated.
- 3 Turn the AM loop antenna until you have the best reception.

### To connect an outdoor AM antenna

When reception is poor, connect a single vinyl-covered wire to the AM EXT terminal and extend it horizontally. The AM loop antenna must remain connected.



#### For better reception of both FM and AM

- Make sure the antenna conductors do not touch any other terminals and connecting cords.
- Keep the antennas away from metallic parts of the unit, connecting cords, and the AC power cord.

## Connecting Speakers

### FOR UX-J66V:

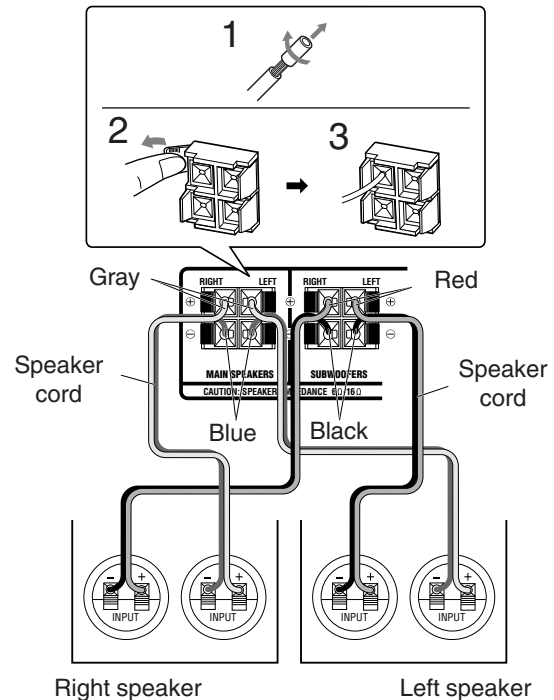

### FOR UX-J55V:

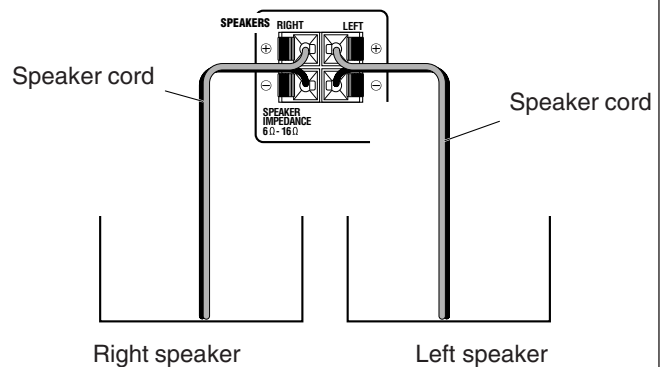

- 1 If the cords are covered with insulation, remove a short section of insulation at the end of each cord by twisting and pulling it off.
- 2 Press and hold the clamp of the speaker terminal as illustrated.
- 3 Insert the end of the speaker cord into the terminal.  
Match the polarity between the unit and the speaker terminals: ⊕ to ⊕ and ⊖ to ⊖.
- 4 Release your finger from the clamp.



**STOP!**

- DO NOT connect speakers while the power is on.
- DO NOT connect more than one speaker to each speaker terminal.

**IMPORTANT:** Use only speakers with the same speaker impedance as shown on the speaker terminals on the rear of the unit.

### To remove the speaker grilles

The speaker grilles are removable.

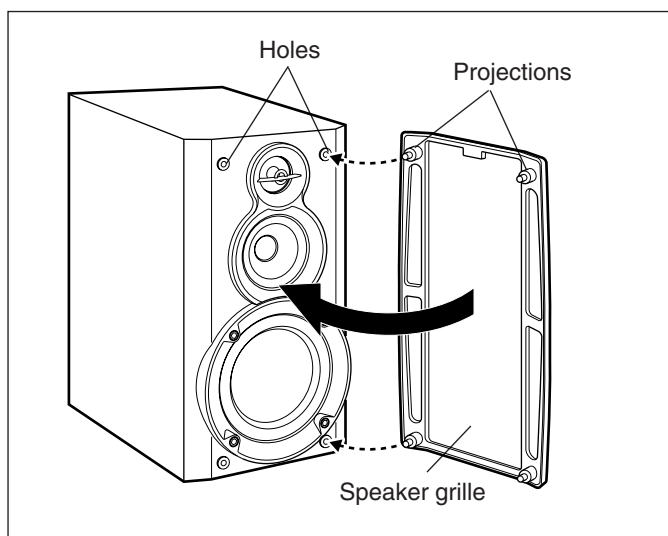

To remove the speaker grille, insert your fingers at the top of the speaker grille, pull towards you. Then pull the bottom towards you.

To attach the speaker grille, put the projections of the speaker grille into the holes of the speaker.

### Connecting Other Equipment

#### To connect an audio equipment

You can connect audio equipment—used only as a playback device.

**STOP!**

- DO NOT connect any equipment while the power is on.
- DO NOT plug in any equipment until all connections are complete.

Be sure that the plugs of the audio cords are colored: White plugs and jacks are for left audio signals, and red ones for right audio signals.

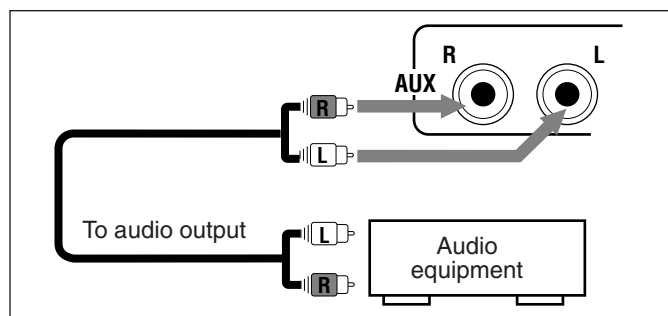

For playing other equipment through this unit, connect between the audio output jacks on the other equipment and AUX jacks by using audio cords (not supplied).

#### To connect a TV set

You can connect a TV with a video input jack: used as a monitor for video CD playback.

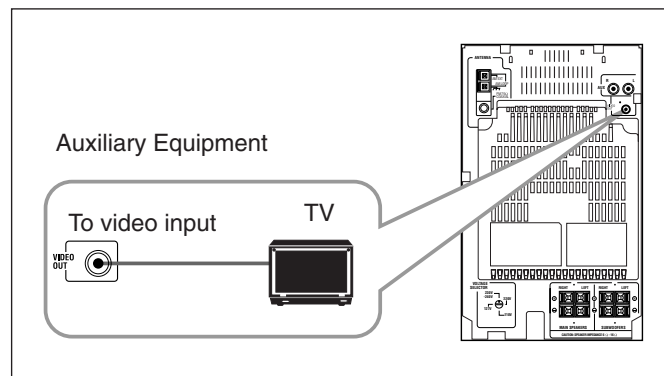

### Adjusting the Voltage Selector

Before plugging in the unit, set the correct voltage for your area with the voltage selector on the rear of the unit.

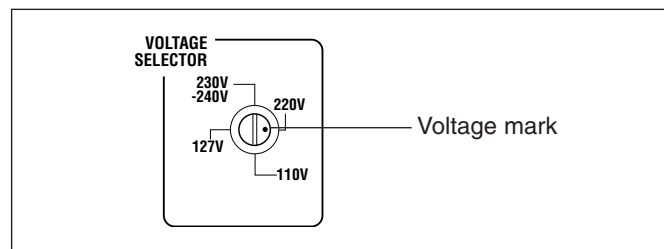

Use a screwdriver to rotate the voltage selector so the voltage number the voltage mark is pointing at is the same as the voltage where you are plugging in the unit. (See the back cover page.)

**STOP!**

DO NOT plug in before setting the voltage selector on the rear of the unit and all connection procedures are complete.

### Now, you can plug the AC power cord.

- If the wall outlet does not match the AC plug, use the supplied AC plug adaptor.

**IMPORTANT:** Be sure to check all connections to be done before plugging the AC power cord into a wall outlet.

# Common Operations

## Setting the Clock

Before operating the unit any further, first set the clock built in this unit. When you plug the AC power cord into the wall outlet, “0:00” starts flashing on the display.

You can set the clock whether the unit is on or off.

- There is a time limit in doing the following steps. If the setting is canceled before you finish, start from step 1 again.

### 1 Press CLOCK/TIMER.

The hour digits start flashing on the display.



### 2 Press UP or DOWN to adjust the hour, then press CLOCK/TIMER.

The minute digits start flashing on the display.

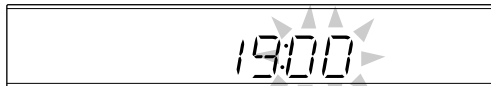
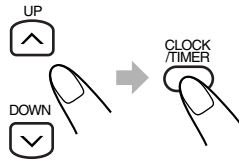

### 3 Press UP or DOWN to adjust the minute, then press CLOCK/TIMER.

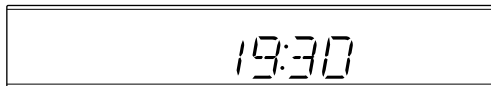

## To check the clock time during play

### On the remote control ONLY:

Press DISPLAY.

- Each time you press the button, the source indication and the clock time alternate on the display.

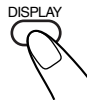

- **When you unplug the AC power cord or if a power failure occurs**  
The clock is reset to “0:00” right away. If this happens, set the clock again.
- **The clock may gain or lose 1 to 2 minutes per month**  
If this happens, set the clock again.

## To change the clock

- 1 **Make sure the ☹ (timer) indicator is not lit on the display.**
  - If it is lit, press and hold CLOCK/TIMER until it goes off.
- 2 **Press CLOCK/TIMER repeatedly until the unit enters the clock setting mode (the hour digits start flashing on the display).**  
First time you press CLOCK/TIMER, the unit enters the timer setting mode. (See page 28.)
- 3 **Repeat steps 2 and 3 of the procedure of “Setting the Clock.”**
- 4 **Press and hold CLOCK/TIMER again so that the ☹ (timer) indicator goes off.**

## Setting the AM Tuner Interval Spacing

Some countries space AM stations 9 kHz apart, and some countries use 10 kHz spacing.

When shipped, the built-in AM tuner is set to 9 kHz spacing. You can change it to 9 kHz or 10 kHz spacing only while the unit is on standby.

### On the unit ONLY:

To select 10 kHz intervals, press FM/AM while holding ►►.



To select 9 kHz intervals, press FM/AM while holding ◀◀.





### When you change the setting

The preset stations are erased. You will need to preset the stations again. (See page 12.)

## Turning On the Power

To turn on the unit, press STANDBY/ON .

The STANDBY/ON lamp lights green and “HELLO” appears on the display.

- When you press the source button—CD , TAPE , FM/AM, and AUX, the unit automatically turns on and starts playback if the source is ready.

To turn off the unit (standby), press STANDBY/ON  again.

The STANDBY/ON lamp lights red and “GOOD BYE” appears on the display.

- “0:00” flashes on the display until you set the built-in clock. After setting the clock, the clock time will appear on the display while the unit is on standby.

The illumination and display brighten only for 4 seconds by pressing DIMMER.

- A little power is always consumed even while the unit is on standby.

To switch off the power supply completely, unplug the AC power cord from the AC outlet.



**When you unplug the AC power cord or if a power failure occurs**

The clock is reset to “0:00” right away, while the tuner preset stations (see page 12) will be erased in a few days.

## Adjusting the Volume

You can adjust the volume level only while the unit is turned on. The volume level can be adjusted between “VOL MIN” and “VOLUME 1” – “VOLUME 40 (VOL MAX).”

### On the remote control:

Press VOLUME + to increase the volume or press VOLUME – to decrease it.



### On the unit:

Turn VOLUME + / – control clockwise (+) to increase the volume or counterclockwise (–) to decrease it.

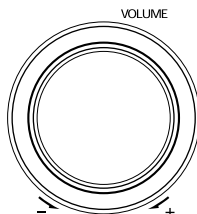

### For private listening

Connect headphones to the PHONES jack.

No sound comes out of the speakers. Be sure to turn down the volume before connecting or putting on headphones.



DO NOT turn the unit off (standby) with the volume set to an extremely high level; otherwise, the sudden blast of sound can damage your hearing, speakers and/or headphones when you turn on the unit or start playing any source next time. REMEMBER you cannot adjust the volume level while the unit is on standby.

## Enjoying Sound Effects

You can adjust the sound by using various sound effect functions.

- These functions only affect the playback sound, and do not affect your recording.

### To adjust the tone (Bass/Treble)

You can adjust the bass level (low frequency range) and the treble level (high frequency range) within a range of –5 to +5. When shipped, the bass level set to “BASS +2” and the treble level set to “TREBLE +2.”

- There is a time limit in doing the following steps. If the setting is canceled before you finish, start over from step 1.
- For UX-J55V only, you can also use BASS and TREBLE on the unit for this operation.

### 1 Press BASS to adjust the bass level or press TREBLE to adjust the treble level.

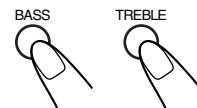

- Each time you press the button, “BASS” and “TREBLE” appears in the display alternately.

### 2 Press UP to increase the level or press DOWN to decrease it.

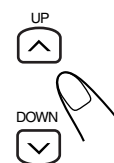

### To reinforce the bass sound

You can reinforce the bass sound to maintain rich, full bass at low volume—Active Hyper Bass Pro.

#### For UX-J66V:

##### Press AHB PRO.

- Each time you press the button, the Active Hyper Bass Pro is turned on (AHB ON) and off (AHB OFF) alternately. When it is turned on, the AHB indicator lights up on the display.

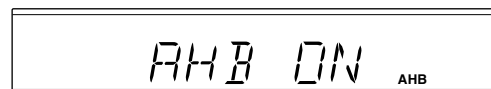

#### For UX-J55V:

##### Press AHB PRO until “AHB 1” or “AHB 2” appears on the display.

The AHB indicator also lights up on the display.

- Each time you press the button, the bass reinforcement changes as follows:

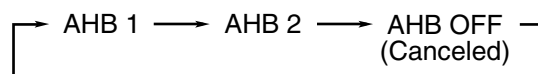

- “AHB 2” has much more bass reinforcement effect than “AHB 1.”

To cancel the effect, press AHB PRO until “AHB OFF” appears on the display and the AHB indicator goes off.

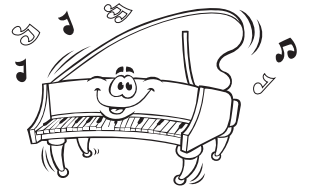

### To enjoy the heavy sound (ONLY FOR UX-J66V)

You can enjoy the heavy sound. The function boosts low and high frequency sounds—Sound Turbo.

#### Press SOUND TURBO.

- Each time you press the button, the Sound Turbo is turned on and off alternately. When it is turned on, the BASS indicator lights up on the display.

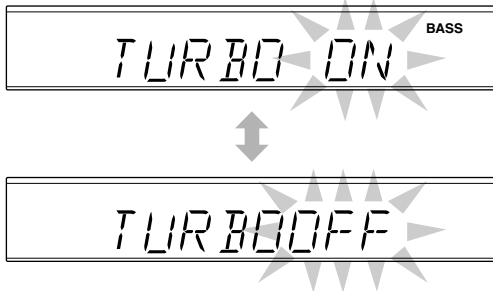

When the Sound Turbo is on, the bass and the treble levels are set to +2 (see page 10). After the Sound Turbo is canceled, these levels restored to the previous levels.

### To reinforce the surround effect (ONLY FOR UX-J66V)

You can reinforce the surround effect.

- This function does not affect your recording and playback sound of monaural sources.

**To get the effect**, press SURROUND so that the SURROUND indicator lights up on the display.



**To cancel the effect**, press SURROUND again so that the SURROUND indicator goes off.

### Selecting the Illumination Brightness

You can change the illumination and display brightness only while the unit is turned on.

#### On the remote control ONLY:

**To change the brightness**, press DIMMER.

- Each time you press the button, the illumination and display dim (DIM ON) and brighten (DIM OFF) alternately.

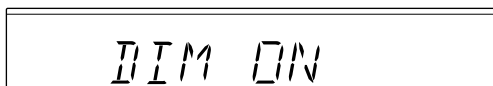

### Selecting the Display Color (ONLY FOR UX-J66V)

You can select the display color (COLOR 1 – COLOR 5 and AUTO mode).

- AUTO mode changes the color (COLOR 1 to COLOR 5) gradually.

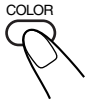

**To select the color**, press COLOR.

- Each time you press the button, the color changes as follows:

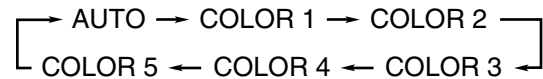

## Tuning in to a Station

- 1 Press FM/AM to select the band.**  
The unit automatically turns on and tunes in to the previously received station—either FM or AM.
  - Each time you press the button, the band alternates between FM and AM.

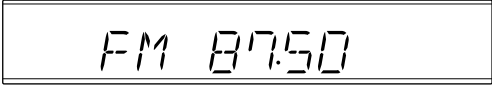

- 2 Press and hold >>> or <<< for more than 1 second.**  
The unit starts searching for stations and stops when a station of sufficient signal strength is tuned in.
  - If a program is broadcast in stereo, the ST (stereo) indicator lights up.

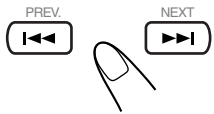

To stop searching, press >>> or <<<.

**notes** When you press >>> or <<< briefly and repeatedly the frequency changes step by step.

### To change the FM reception mode

**On the remote control ONLY:**

When an FM stereo broadcast is hard to receive or noisy, press FM MODE so that the MONO indicator lights up on the display. Reception will improve.



To restore the stereo effect, press FM MODE again so that the MONO indicator goes off. In stereo mode, you can hear stereo sound when a stereo program is broadcast.

## Presetting Stations

You can preset 30 FM and 15 AM stations. In some cases, test frequencies have been already memorized for the tuner since the factory examined the tuner preset function before shipment. This is not a malfunction. You need to preset stations separately for the FM and AM bands.

- There is a time limit in doing the following steps. If the setting is canceled before you finish, start over from step 2.

**On the remote control ONLY:**

- 1 Tune in to the station you want to preset.**
  - See “Tuning in to a Station.”

- 2 Press SET.**



- 3 Press UP or DOWN to select a preset number.**

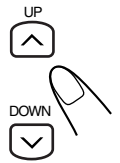

- 4 Press SET again.**



The tuned station in step 1 is stored in the preset number selected in step 3.

- Storing a new station on a used number erases the previously stored one.

**notes** When you unplug the AC power cord or if a power failure occurs

The tuner preset stations will be erased in a few days. If this happens, preset the stations again.



## Tuning in to a Preset Station

### On the remote control ONLY:

#### 1 Press FM/AM to select the band.

The unit automatically turns on and tunes in to the previously received station—either FM or AM.



- Each time you press the button, the band alternates between FM and AM.

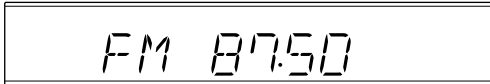

#### 2 Press UP or DOWN to select a preset number.

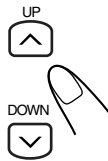

### To tune in to a preset station directly using the number buttons

#### On the remote control ONLY:

Pressing the number button(s) allows you to select the preset number you want.

Ex.: For preset number 5, press 5.



For preset number 15, press +10, then 5.



For preset number 20, press +10, then 10.



For preset number 30, press +10, +10, then 10.





# Disc Introduction



This unit has been designed to playback the following CDs:

- CD (Audio CD)
- CD-R (CD-Recordable)
- CD-RW (CD-Rewritable)
- MP3 disc (MP3 files recorded on a CD-R or CD-RW)

## What is MP3?

MP3 is an abbreviation of Motion Picture Experts Group 1 (or MPEG-1) Audio Layer 3. MP3 is simply a file format with a data compression ratio of 1:10 (128 kbps\*). By using MP3 format, one CD-R or CD-RW can contain 10 times as much data volume as a regular CD can.

\* Bit rate is the average number of bits that one second of audio data will consume. The unit uses kbps (1,000 bits per second). To get a better audio quality, choose a higher bit rate. The most popular bit rate for encoding (recording) is 128 kbps.

## MP3 disc structure

On an MP3 disc, each song (material) is recorded as a file. Files are grouped into a directory (or folder). Directories can also include other directories, creating hierarchical directory layers. (See “How are MP3 files recorded and played back?”).

This unit manages files and directories as “tracks” and “groups.” This unit can recognize up to 255 tracks, up to 64 groups per disc. The unit ignores those exceeding the maximum numbers and cannot play them back.



### About MP3 discs

- MP3 discs (either CD-R or CD-RW) require a longer readout time. (It varies due to the complexity of the recording configuration.)
- When making an MP3 disc, select ISO 9660 Level 1 or Level 2 as the disc format.
- This unit does not support multisession recording.
- This unit can play MP3 files only with the following file extensions—“.MP3”, “.Mp3”, “.mP3”, and “.mp3.”
- Files other than MP3 are ignored.
- Some MP3 discs may not be played back because of their disc characteristics or recording conditions.

## How are MP3 files recorded and played back?

MP3 “tracks (files)” can be recorded in “group”—folders or directories, in PC terminology.

During recording, the tracks and groups can be arranged similarly to the tracks and folders/directories of computer data. “Root” is similar to the root of a tree. Every track and group can be linked to the root.

In compliance with ISO 9660, the maximum allowable depth of nested directories—so called “hierarchy”—is eight (inclusive of the root).

Playback order, track search order, and group search order of the MP3 tracks recorded on a disc are determined by the writing (or encoding) application; therefore, playback order may be different from the one you have intended while recording the groups and the tracks.

The illustration shows an ordinary example of how MP3 tracks are recorded on a CD-R or CD-RW, how they are played back and how they are searched for on this unit.

- The numbers in circles next to the MP3 tracks (♪) indicate the playback order and search order of the MP3 tracks. Normally this unit plays back MP3 tracks in the recorded order.
- The numbers inside the groups indicate the playback order and search order of the groups on an MP3 disc. Normally this unit plays back MP3 tracks in the groups in the recorded order. The groups marked with asterisk (\*) will be skipped since they do not include any MP3 tracks.

## MP3 group/track configuration:

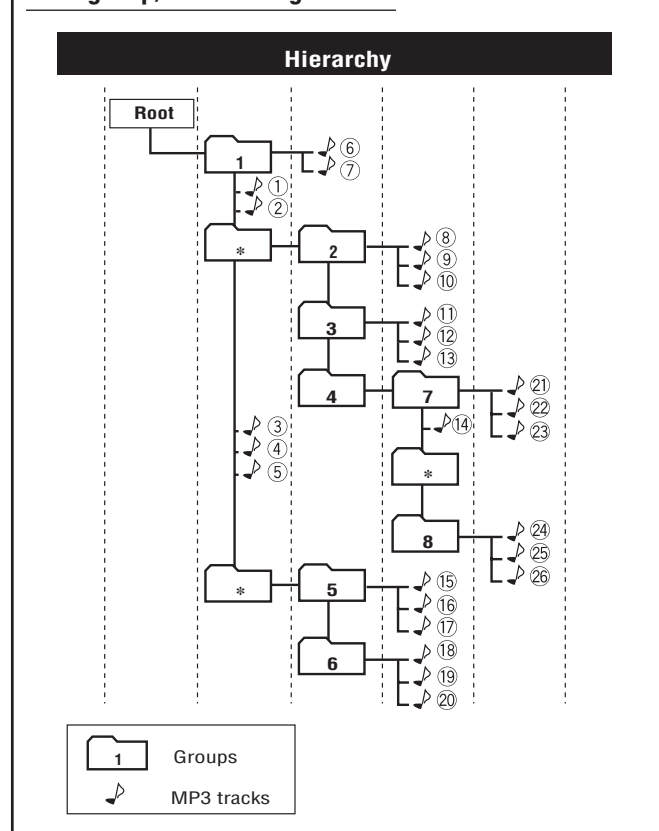

# Playing Back Discs (CD/CD-R/CD-RW/MP3)

Continued 

## When playing a CD-R or CD-RW

User-edited CD-Rs (CD-Recordable) and CD-RWs (CD-ReWritable) can be played only if they are already “finalized.”

- Usually you can play back your original CD-Rs or CD-RWs recorded in music CD format. However, sometimes they may not play depending on their characteristics or recording conditions.
- Before playing CD-Rs or CD-RWs, read their instructions or cautions carefully.
- Some CD-Rs or CD-RWs may not play on this unit because of their disc characteristics, damage or stain on them, or if the player’s lens is dirty.
- CD-RWs may require a longer readout time. This is because the reflectance of CD-RWs is lower than for regular discs.

## General notes

In general, you will have the best performance by keeping your discs and the mechanism clean.

- Store discs in their cases, and keep them in cabinets or on shelves.
- Keep the unit’s disc tray closed when not in use.

Continued use of irregular shape discs

(heart-shape, octagonal, etc.) can damage the unit.

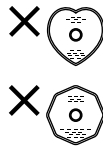

## Handling discs

- Remove the disc from its case by holding it at the edge while pressing the center hole lightly.
- Do not touch the shiny surface of the disc, or bend the disc.
- Put the disc back in its case after use to prevent warping.
- Be careful not to scratch the surface of the disc when placing it back in its case.
- Avoid exposure to direct sunlight, temperature extremes, and moisture.

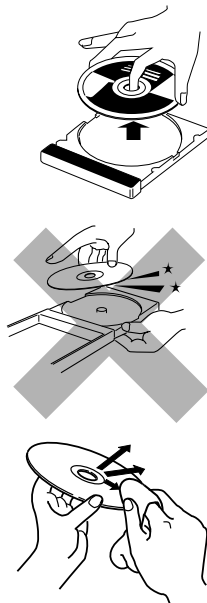

## To clean the disc

Wipe the disc with a soft cloth in a straight line from center to edge.

DO NOT use any solvent—such as conventional record cleaner, spray, thinner, or benzene—to clean the disc.

## Playing Back the Entire Disc—Normal Play

### ■ For Audio CDs

#### 1 Press CD ▲.

The unit automatically turns on and the disc tray comes out.

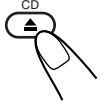

#### 2 Place a disc correctly on the circle of the disc tray, with its label side up.

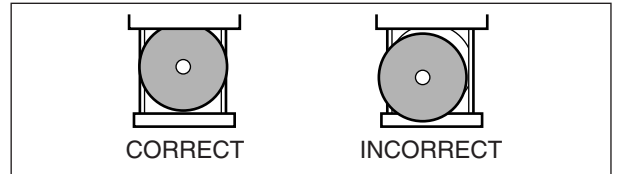

- When using a CD single (8 cm), place it on the inner circle of the disc tray.

#### 3 Press CD ►/II.

The disc tray automatically closes and the first track of the disc starts playing.

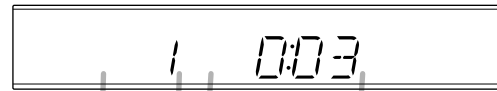

Track number      Elapsed playing time

- The disc automatically stops when the last track has finished playing.

To stop playing, press ■.

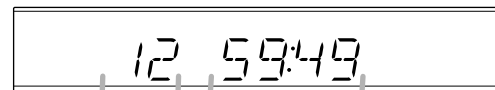

Total track number      Total playing time

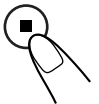

To remove the disc, press CD ▲.



- If the disc cannot be read correctly (because it is scratched, for example) or an unreadable CD-R or CD-RW is inserted Playback will not start.
- If no disc is inserted “NO DISC” appears on the display.



DO NOT try to open or close the disc tray by hand as it will be damaged.

## ■ For MP3 discs

### 1 Load a disc.

The unit searches for the disc (it may take some time), and the following information appears on the display (the group title will scroll on the display).

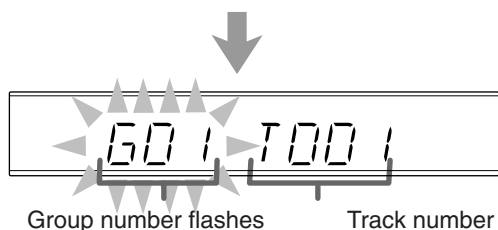
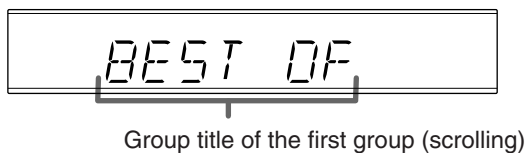

- 2 Press **▶▶|** NEXT or PREV **|◀◀** (or **▶▶|** NEXT/PREV **|◀◀** on the remote control) to select a group you want, then press **CD ▶/||**.** The group number, track number and track title will scroll on the display.

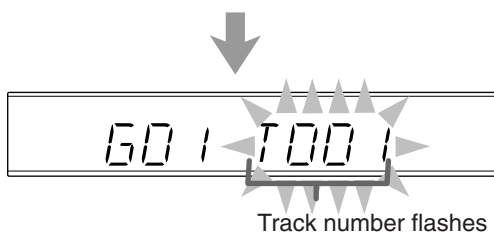
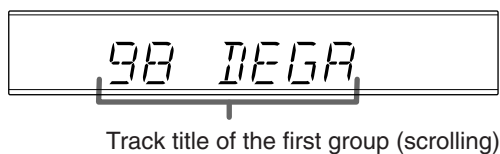

- 3 Press **▶▶|** NEXT or PREV **|◀◀** (or **▶▶|** NEXT/PREV **|◀◀** on the remote control) to select a track you want to start playback with, then press **CD ▶/||** again.**



Only a maximum of 14 characters (including spaces between words) can scroll on the display. The exceeding characters will be ignored.

To stop playing, press **■**.

To remove disc, press **▲** for the corresponding disc tray.



- If the CD cannot be read correctly (because it is scratched, for example) or an unreadable CD-R or CD-RW is inserted Playback will not start.
- If no CD is inserted “NO DISC” appears on the display.



DO NOT try to open or close the CD tray by hand as it will be damaged.

## Basic Disc Operations

While playing a disc, you can do the following operations.

### To stop playing for a moment

During play, press **CD ▶/||**.

While pausing, the elapsed playing time flashes on the display.



To resume playing, press **CD ▶/||** again.

### To go to another track

Before or during play, press **▶▶|** or **|◀◀** repeatedly.

- **▶▶|**: Skips to the beginning of the next or succeeding tracks.
- **|◀◀**: Goes back to the beginning of the current or previous tracks.



### To go to another track directly using the number buttons

**On the remote control ONLY:**

Pressing the number button(s) before or during play allows you to start playing the track number you want.

Ex.: For track number 5, press 5.

For track number 15, press +10, then 5.

For track number 20, press +10, then 10.

For track number 32, press +10, +10, +10, then 2.

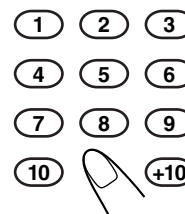

### To locate a particular point in a track

During play, press and hold **▶▶|** or **|◀◀**.

- **▶▶|**: Fast-forwards the tracks.
- **|◀◀**: Fast-reverses the tracks.



## Programming the Playing Order of the Tracks —Program Play

You can arrange the order in which tracks play before you start playing. **You can program up to 50 tracks.**

### On the remote control ONLY:

#### 1 Load a disc.

- If the current playing source is not the CD player, press CD ►/||, then ■ before going to the next step.

#### 2 Press PRGM (program).

The PRGM (program) indicator lights up on the display.



- If a program has been stored in memory, the program is called up.

#### 3 Press UP or DOWN to select the track number, then press SET.

- You can select the track number directly using the number button(s). (See “To go to another track directly using the number buttons.”)

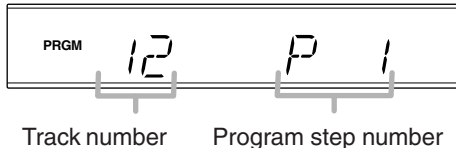

#### 4 Repeat step 3 to program other tracks you want.

#### 5 Press CD ►/||.

The tracks are played in the order you have programmed.



**If you try to program a 51st track**

“FULL” will appear on the display.

To stop playing, press ■.

To exit from Program Play, press PRGM (program) before or after playing.

- The PRGM (program) indicator goes off.

### To check the program contents

You can check the program contents by pressing ►►1 or 1◀◀ before or after playback.



- 1: To check the contents in the programmed order.
- 1◀◀: To check the contents in the reverse order.

### To modify the program

#### On the remote control ONLY:

Before or after playing, you can erase the last programmed track by pressing CANCEL.

- Each time you press the button, the last programmed track is erased from the program.

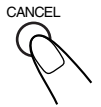

To add tracks in the program before playing, simply select the track numbers you want to add by following step 3 of the programming procedure.

To erase the program, press ■ before or after playing.

- Disc ejection also erases the program.

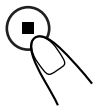

If additional track cannot add into the program list, repeat from step 1.

## Playing at Random—Random Play

The tracks will play in no particular order when you use this mode.

### On the remote control ONLY:

#### 1 Load a disc.

- If the current playing source is not the CD player, press CD ►/||, then ■ before going to the next step.

#### 2 Press RANDOM.

The RANDOM indicator lights up on the display.

#### 3 Press CD ►/||.

The tracks are randomly played. Random Play ends when all the tracks are played once.

To skip the current track, press ►►1.

- You cannot go back to the previous track by pressing 1◀◀.

To stop playing, press ■.

To exit from Random Play, press RANDOM before or after playing.

Random Play is canceled and Normal Play resumes.

- The RANDOM indicator goes off.

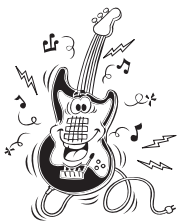

## Repeating Tracks—Repeat Play

You can have all the tracks, the program or individual track currently playing, repeat as many times as you like.

### On the remote control ONLY:

To repeat playing, press REPEAT before or during play.

- Each time you press the button, Repeat Play changes as follows, and the following repeat indicator lights up on the display:

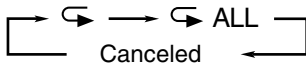

- ↶ : Repeats one track.
- ↶ ALL : In Normal Play, repeats all the tracks.  
In Program Play, repeats all the tracks in the program.  
In Random Play, repeats all the tracks in random order.

To cancel Repeat Play, press REPEAT repeatedly until the repeat indicator goes off.

## Prohibiting Disc Ejection—Tray Lock

You can lock the disc tray and prohibit ejecting the disc whether the unit is on or off.

### On the unit ONLY:

To prohibit disc ejection, press CD ▷/|| while holding ■.

- If the disc tray is opened, close it first.

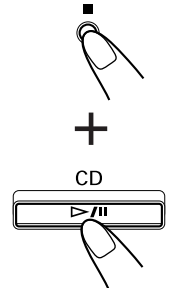
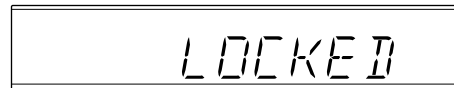

To cancel the prohibition and unlock the disc, press CD ▷/|| while holding ■.

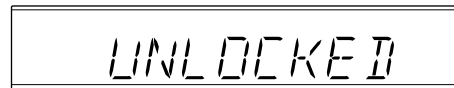

If you try to eject the disc while Tray Lock is in use “LOCKED” appears to inform you that the disc tray is locked.

# Using the Video CD Player (Video CDs)

You can play video CDs (with or without the Playback Control (PBC) function) to watch the picture on your TV while listening to the sound through your JVC Micro Component System.



## Before playing video CDs

Make sure that the connection between the System and your TV is correct. (See page 8)

## Setting the TV System

To view a picture of video CDs, it is required that you set your CD player's TV output mode according to your TV's color system.

### Relationship among the playable CDs, System's TV output mode and your TV's color system:

Playable CD	Player's TV output mode	Your TV's color system
NTSC/PAL	NTSC	NTSC
NTSC/PAL	PAL	PAL
NTSC/PAL	PAL AUTO	Multisystem

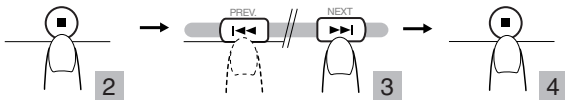

- 1 Turn off the power to put the System into Standby mode.**
- 2 Press the ■ button on the Unit for more than 2 seconds.**  
The current TV output mode ("NTSC" for example) appears on the display for five seconds.
- 3 Within five seconds, press the ►►| NEXT or PREV |◄◄ button on the Unit to select the System's TV output mode.**  
Each time you press the button, the TV output mode changes as follows:  
NTSC ⇄ PAL ⇄ PAL AUTO ⇄ (back to beginning)  
NTSC: for NTSC exclusive TV  
PAL: for PAL exclusive TV  
PAL AUTO: for multisystem TV
- 4 Within five seconds, press the ■ button on the Unit to apply the changes.**
- 5 Turn on the TV and select the video input on the TV.**
- 6 Press the SELECT CD ►/|| button to turn on the System.**  
"JVC VIDEO CD/CD PLAYER" screen will appear on the TV without distortion.



- If you play an NTSC CD in PAL AUTO mode on a PAL exclusive TV, the image may be distorted. If this happens change the CD Player's TV output mode to "PAL".
- When you play an NTSC CD in PAL AUTO mode on a multisystem TV, the image may blink for a moment. This symptom occurs when the System detects the formula of the CD and is not a malfunction.
- You can configure the current TV output mode by pressing the ■ button on the Unit for more than 2 seconds during standby mode.

## Playing Video CDs with the PBC Function

The System provides Playback Control (PBC) which utilizes a procedure (menu selection) programed into a VCD.

### What is the Playback Control (PBC) function?

PBC allows you to enjoy the following features:

- **Menu-Driven Play**  
You can interact with the TV screen using a menu display to select and play an entry.
- **High resolution still image playback**  
You can display high-quality images four times clearer than video pictures.

To use a Karaoke video CD, see page 26.

You can play video CDs with PBC function using the menu screen (Menu-Driven Play) or without using the menu screen (Continuous Play).



- The playback operation procedure may differ depending on the video CD you use.
- Sometimes due to improper manufacturing, video CDs will function differently.

## Playing Video CDs with the PBC Function without Using the Menu Screen (Continuous Play)



You can play video CDs with PBC without using the menu screen, as if the CDs had no PBC function.

- 1 Load a video CD with PBC.**
- 2 Press the CD ►/|| button.**

### Program Play, Random Play, Repeating Tracks:

Select the mode by pressing the respective button on the Remote Control in the same way as for audio CDs. (See pages 17 and 18)

## Playing Video CDs with the PBC Function Using the Menu Screen (Menu-Driven Play)

Before playing, make sure that Repeat indicator “” or “ ALL” is not lit. If lit, press the REPEAT button on the Remote Control until the repeat indicator goes off.

### 1 Load a video CD with PBC.

Do not press the CD  button yet.

### 2 Press PBC button on the Remote Control.

### 3 Press the CD button.

“PLAY” appears on the display and the first menu will appear on the TV screen.

- If you leave your System on its own, the TV screen will change as follows:  
This depending on the disc you use.

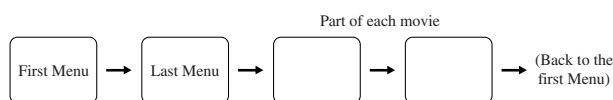

To return to the previous menu, press the RETURN button on the Unit or the RETURN button on the Remote Control.

### 4 To move through the next menu, press the following buttons.

#### On the Unit:

Press the  NEXT or PREV  button.



#### On the Remote Control:

Press the NEXT  or PREV  button.

### 5 To select the item (track) in the menu and play it, press the following buttons.

#### On the Unit (Only for UX-J55V):

- Press the VCD NUMBER button for more than 2 seconds. “SEL 1” will blink on the display.

- Press the  NEXT/PREV  buttons to select the item (“SEL XX”) and press the SELECT CD  button to play it back.

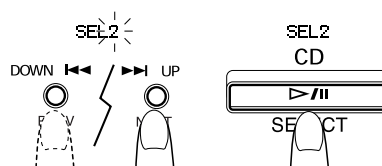

#### On the Remote Control:

Pressing the number button(s) allows you to start playing the track number you want.

Ex.: For track number 5, press 5.

For track number 15, press +10, then 5.

For track number 20, press +10, then 10.

For track number 32, press +10, +10, +10, then 2.

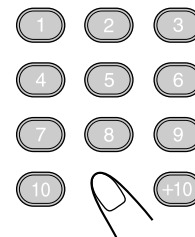

- The next track will be automatically played after the current track is finished.

**To pause**, press the CD  button on the Remote Control.

**To stop playback and return to the first menu**, press the RETURN button repeatedly.

**To stop the video CD**, press  button.

**To select other items during playback**, repeat step 4.











- Program Play, Random Play and Repeating Tracks cannot be performed during Menu-Driven Play.

#### Reminder!

Do not pause Video CD for more than 10 minutes to prevent screen burns.

### Basic Remote Control and Unit Button Functions for Menu-Driven Play:

Remote Control	Unit*	Function
PREV  / NEXT 	PREV  /  NEXT	Move through menu.
Number button	VCD NUMBER ↓ PREV  /  NEXT (Only for UX-J55V)	Select a specific menu item.
	SELECT CD 	Enters the selected video CD number or item. When a part of movie is displayed on the TV screen, starts playing that track from the beginning.
 RETURN	RETURN	Returns to the previous menu during playback.

\* The PBC function button names on the unit and the remote control are printed in orange.

## Example of playback using Playback Control (PBC)

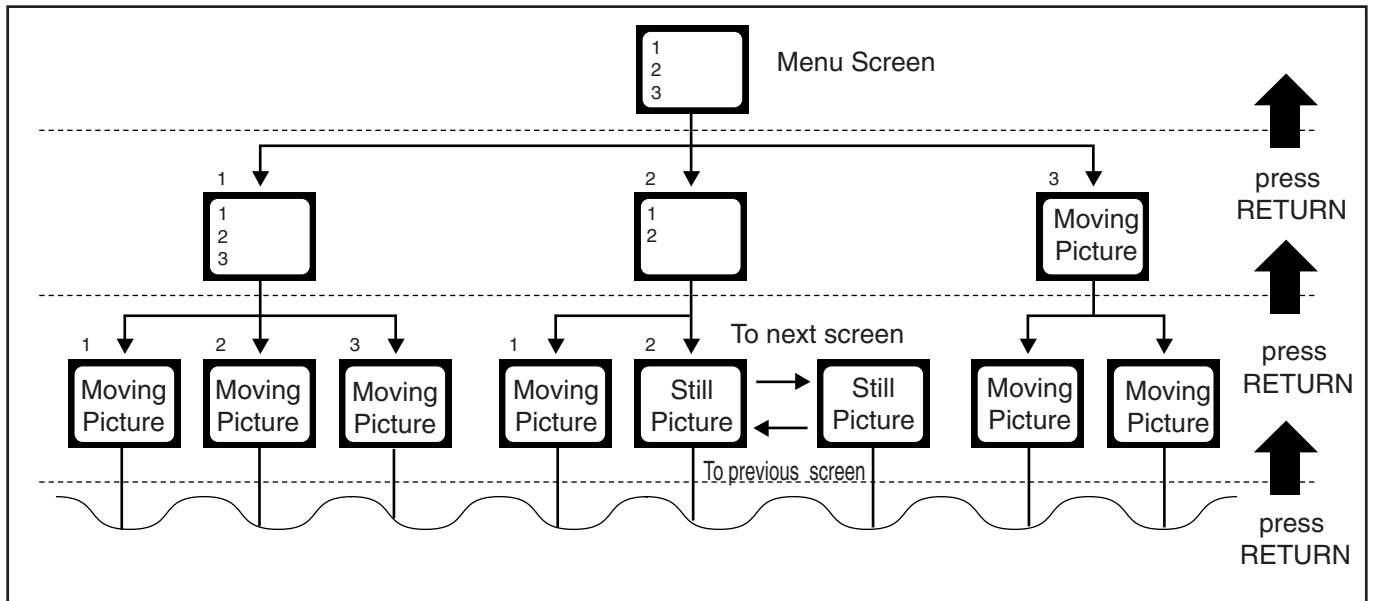

A selection menu is displayed when you start playing a video CD with PBC. The selection menu shows a list of numbers for selection. Some video CDs may show moving pictures or a divided screen.

- When a list of numbers is displayed, selecting a number shows its contents.
- When a moving picture is displayed, pressing SELECT CD ►/|| when the part of the movie you desire is shown plays the movie.
- When the selection menu is re-displayed after you have played your selection, selecting a number again can replay its contents. (Some video CDs may show the menu screen several times)  
When “NEXT” and “PREV” are shown, pressing ►► NEXT or PREV ◀◀ can change the selection menu.
- After playback, press RETURN to go back to the previous screen. After playback, pressing RETURN for 2 seconds or more causes it to stop. Some video CDs may return you to the menu screen shown before playback.



- When a menu screen of a karaoke disc is displayed for about a few minutes without any selection being made, it automatically starts playing from the first song.
- When using the REPEAT function, the PBC function is not available.

## Playing video CDs without the PBC Function

Basic playback procedures for video CDs are the same as for audio CDs. (See pages 15 and 16)

- When you start playing a video CD without PBC, “VIDEO CD” appears on the display.



- During playback of a video CD, the following operations may distort the image on the TV screen.  
Searching for the beginning of the track, Skipping tracks, Stopping/pausing the tracks, or frame-by-frame playback.

## Various Functions to Enhance Your Enjoyment

You can use the following features using the Remote Control.

### Frame-by-Frame Playback

Frame-by-Frame playback is possible only when moving pictures (the video CDs with or without PBC) are played.

### During playback, press the STILL button to pause the video CD.

Each time you press the STILL button, the picture advances by one frame. During Frame-by-Frame playback, no sound will be heard.

To resume Normal Play, press the CD ►/|| button.



- You cannot return to the previous frame.





## Display of Operating Status

You can view the current operating status on the TV screen.

### Press the ON SCREEN button.

Pressing the above button alternates between on-screen display ON and OFF.

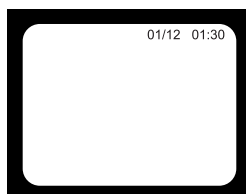

- Once you have turned on the on-screen display, the track number and playing time are always displayed on the TV screen.

## Viewing the Video Intro of Video CDs

You can check the contents of a video CD, watching about 7 seconds at the beginning of each track on the disc.

### 1 Play the video CD with or without PBC.

- Load the video CD with or without PBC.
- Press the CD ►/|| button, then press the ■ button.

### 2 Press the VIDEO INTRO button.

The Video Intro play starts whereby about 7 seconds at the beginning of the first nine tracks will be played in sequence.

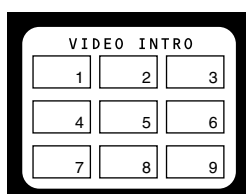

- If the video CD has more than nine tracks, the tracks whose track number is greater than nine will be displayed on the next page when the ^ UP or ►►| NEXT is pressed.
- This function is not available in PBC mode or during playback.

**To select a track during Video Intro Play,** press the number buttons on the Remote Control to select the track to play. Continuous play starts from the selected track.

When you use the Unit for UX-J55V, press the VCD NUMBER button for more than 2 seconds and press the PREV ◀◀ or ►►| NEXT buttons to select the track, then press the SELECT CD ►/|| button.

**To stop and cancel the Video Intro Play,** press the ■.



Stop the Video CD playback before enter the video intro mode.

# Playing Back Tapes



You can play back type I tapes.

## Playing Back a Tape

### 1 Press PUSH OPEN ▲ on the unit.

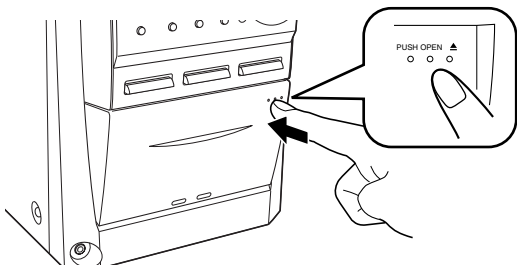

### 2 Put a cassette in with the exposed part of the tape down.

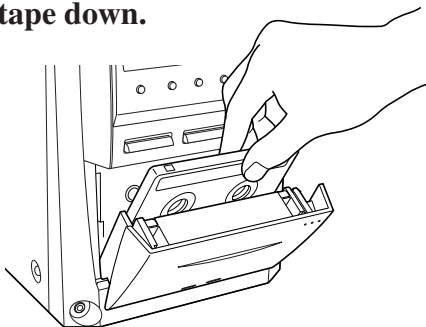

### 3 Press PUSH OPEN ▲ again to close the cassette holder.

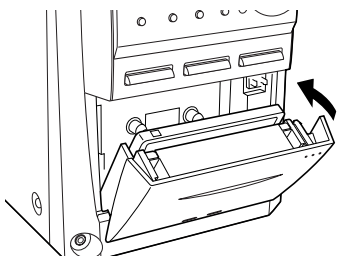



### 4 Press TAPE ◀▶.

The unit automatically turns on and the tape starts playing. The tape direction indicator (▶ or ◀) flashes slowly on the display.

- Each time you press the button, the tape direction changes:
  - ▶ : plays the front side.
  - ◀ : plays the reverse side.





When the tape plays to the end, the deck automatically stops if the Reverse Mode is set to  or . (See “To play both sides—Reverse Mode.”)

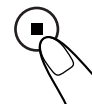

If no cassette is inserted when you press TAPE ◀▶ “NO TAPE” appears on the display.

To stop playing, press ■.



To fast-wind to the left or to the right, press  or  while the tape is not running.

The tape direction indicator (▶ or ◀) starts flashing rapidly on the display.



To remove the cassette, press PUSH OPEN ▲ on the unit.

- If the tape is playing, stop it first.

### To play both sides—Reverse Mode

You can set the deck to play just one side of a tape, both sides once, or both sides continuously.

Press REV.MODE (reverse mode).

- Each time you press the button, the Reverse Mode changes as follows:

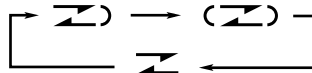

 : The deck automatically stops after playing both sides of the tape. Stops when playback in the ◀ direction is finished.

 : The deck continues to play both sides of the tape until ■ is pressed.

 : The deck automatically stops after playing one side of the tape.



- DO NOT open the cassette holder when the tape is running.
- The use of C-120 or thinner tape is not recommended, since characteristic deterioration may occur and this tape easily jams in the pinch-rollers and the capstans.

## IMPORTANT:

- It may be unlawful to record or play back copyrighted material without the consent of the copyright owner.
- The recording level is automatically set correctly, so it is not affected by the other sound settings. Thus, during recording you can adjust the sound you are actually listening to without affecting the recording level.
- If recordings you have made have excessive noise or static, the unit may be too close to a TV. Increase the distance between the TV and the unit.
- You can use type I tape for recording.

## To protect your recording

Cassettes have two small tabs on the back to protect from unexpected erasure or re-recording.

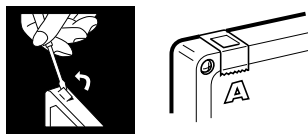

To protect your recording, remove these tabs.

To re-record on a protected tape, cover the holes with adhesive tape.

## To keep the best recording and playback sound quality

If the heads, capstans, and pinch rollers of the cassette deck become dirty, the following will occur:

- Impaired sound quality
- Discontinuous sound
- Fading
- Incomplete erasure
- Difficulty in recording

## To clean the heads, capstans, and pinch rollers

Use a cotton swab moistened with alcohol.

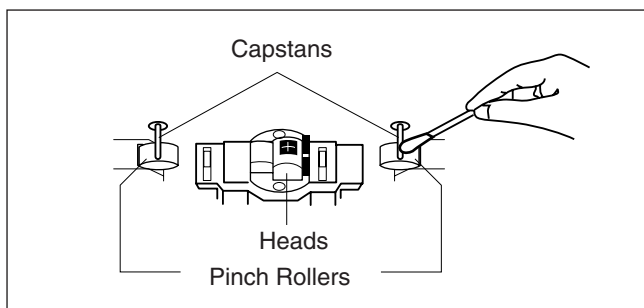

## To demagnetize the heads

Turn off the unit, and use a head demagnetizer (available at electronics and audio shops).



### At the start and end of cassette tapes

There is leader tape which cannot be recorded onto. Thus, when recording discs or radio broadcasts, wind the leader tape first to ensure that the recording will be made without any loss.

## Recording on a Tape

### On the unit ONLY:

- 1 Put a recordable cassette in with the exposed part of the tape down.

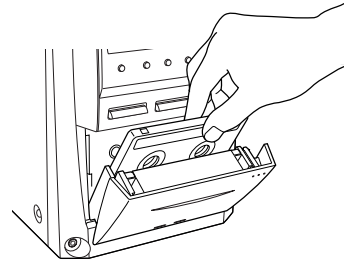

- 2 Close the cassette holder gently and check the recording direction for the tape.

- If the tape direction is not correct, press TAPE ◀▶ twice then ■ to change the tape direction.
- If you want to record on both sides of a tape, see “To record on both sides—Reverse Mode.”

- 3 Start playing the source—FM, AM or auxiliary equipment connected to AUX jacks.

- When the source is the CD player, see “Disc Direct Recording” on page 25.

- 4 Press REC (recording).

The REC (recording) indicator lights up on the display and recording starts.

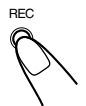

- If no cassette is inserted when you press REC “NO REC” appears on the display.
- If a protected tape is inserted when you press REC “NO REC” appears on the display.

To stop while recording, press ■.

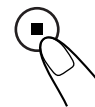

To remove the cassette, press PUSH OPEN ▲ on the unit.

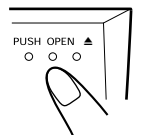



- If the tape is recording, stop it first.



DO NOT open the cassette holder when the tape is running.

## To record on both sides—Reverse Mode

Press REV.MODE (reverse mode) repeatedly until  or  is lit.

- When using the Reverse Mode for recording,  lights up and start recording in the forward (▶) direction first. Otherwise, recording will stop when recording is done only on one side (reverse) of the tape.





## Disc Direct Recording

Everything on the disc goes onto the tape in the order it is on the disc, or according to the order you have set in Program Play.

**On the unit ONLY:**

- 1 Put a recordable cassette in with the exposed part of the tape down.**
- 2 Load a CD.**
  - If the current playing source is not the CD player, press CD ►/||, then ■ before going to the next step. — A non-recorded pause of about 4 seconds will be automatically inserted between tracks. If you do not want a 4 seconds pause between tracks, press CD ►/|| twice.
  - If you want to record on both sides of a tape, see “To record on both sides—Reverse Mode.”
- 3 Press REC (recording).**

The REC (recording) indicator lights up on the display and recording starts.

After recording, the CD player and cassette deck automatically stop.



**To stop while recording, press ■.**  
The tape stops after 4 seconds.

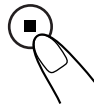

**To remove the cassette, press PUSH OPEN ▲**  
on the unit.

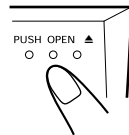

- If the tape is recording, stop it first.



**DO NOT** open the cassette holder when the tape is running.

## One Track Recording

This recording method is convenient when you record tracks while playing the disc. You can record just your favorite songs on the tape.

**On the unit ONLY:**

- 1 Put a recordable cassette in with the exposed part of the tape down.**
- 2 Play the track on the disc you wish to record.**
- 3 Press REC (recording).**

The CD player returns to the beginning of that track and the track is recorded on the tape.

After recording, the CD player and cassette deck automatically stop.
- 4 Repeat steps 2 and 3 to record other tracks you want.**



**To stop while recording, press ■.**  
The tape stops after 4 seconds.

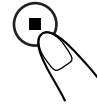

**To remove the cassette, press PUSH OPEN ▲**  
on the unit.

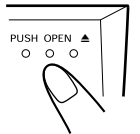



- If the tape is recording, stop it first.



**DO NOT** open the cassette holder when the tape is running.

## To record on both sides—Reverse Mode

Press REV.MODE (reverse mode) repeatedly until  or  is lit.



- When using the Reverse Mode for Disc Direct Recording,  lights up and start recording in the forward (►) direction first. When the tape reaches its end while recording a song in the forward direction (►), the last song will be re-recorded at the beginning of the reverse side (◄).
- If you start recording on the reverse side (◄), recording will stop when recording is done only on one side (reverse) of the tape.



**When making Sleep Timer settings while doing Disc Direct Recording**

Set enough time to allow for the disc to finish playing; otherwise, the power will go off before recording is completed.

# Using the Microphone and Multiplex CDs

By plugging in the microphone, you can use the System for Karaoke or microphone mixing. You can also add an echo to the microphone's sound.



**Karaoke and microphone mixing are only available when you select the CD source with a playable disc inside.**

- When you will not be using the microphone, keep the MIC VOLUME control set to MIN and disconnect the microphone.



Always set the MIC VOLUME control to MIN when connecting or disconnecting the microphone.

## Singing Along — Karaoke

You can enjoy singing along using audio CDs and video CDs (Karaoke does not function for other sources such as tapes). While singing along, you can apply echo.

### Singing Along with Audio CDs — Vocal Masking

When playing an audio CD, you can reduce the lead vocal and replace it with your voice by singing into the microphone.

The following CDs are not suitable for Vocal Masking.

- Monoaural CDs
- Multiplex Karaoke CDs
- CD recorded duets, strong echo, a chorus, or only a few instruments

- 1 Set the MIC VOLUME control to MIN by turning it anti-clockwise.**
- 2 Connect the microphone by plugging it into the MIC jack.**
- 3 Press the KARAOKE button on the Remote Control until “V.MASK” appears on the display.**  
Each time you press the button, the “V.MASK” and “NORMAL” appears on the display alternately as shown below:  

NORMAL (KARAOKE OFF)	→	V.MASK (KARAOKE ON)
↑		↓
- 4 Play a CD.**
- 5 Adjust the main volume and the MIC VOLUME control, as you sing into the microphone.**
  - If you want to record on a tape, carry out CD Direct Recording or One Track Recording. (See page 25)

To cancel the Karaoke mode, press the KARAOKE button on the Remote Control until “NORMAL” appears on the display.



- After you have finished singing along, always cancel the Karaoke mode.
- If “howling” occurs, keep the microphone away from the speakers.
- During recording, you cannot change the Vocal Masking.

### Applying an echo to your voice

You can apply echo to your voice through the microphone during CD mode only.

Press the DIGITAL ECHO button on the Remote Control until “ECHO ON” appears on the display.

Pressing the button alternates between echo ON and OFF. “ECHO ON” and “ECHO OFF” will appear on the display for 3 seconds.

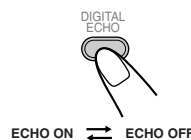

To cancel the echo, press the DIGITAL ECHO button again until “ECHO OFF” appears on the display.



During recording, you cannot switch the echo.



Always set the MIC VOLUME control to MIN when connecting or disconnecting the microphone.

## Microphone Mixing

Using a microphone, you can mix the microphone sound with a CD sound.

- 1 Set MIC VOLUME control to MIN by turning it fully anti-clockwise.**
- 2 Connect a microphone (not supplied) by plugging it into the MIC jack.**
- 3 Start the source: CD Only.**

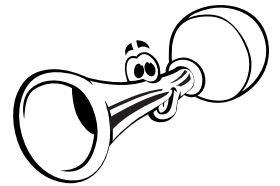

Microphone mixing is not available for other sources such as Tape, Tuner or Aux.

#### 4 Adjust the main volume and the MIC VOLUME control as you sing into the microphone.

- To apply echo, press the DIGITAL ECHO button on the Remote Control until “ECHO ON” appears on the display. To cancel the echo, press the same button again. “ECHO OFF” will appear on the display.



If “howling” occurs, keep the microphone away from the speakers.

### To Record Microphone Mixing on a Tape

- Follow the above steps 1-4.
- To record, follow the steps in “Recording on a Tape”. (See page 24)

### Using the Multiplex CDs and Singing Along with Multiplex (MPX) Karaoke CDs

If the source you are going to play is a multiplex CD, you can use the Multiplex Sound function.

#### What is Multiplex Sound?

In a multiplex Karaoke CD, the instrumental parts are recorded on the left channel and the vocal parts are recorded on the right channel. With this system, you can select the playback sound with your voice through the microphone (With this system, you can select each channel separately).

- Turn on the TV and select the video input on the TV.
- Set the MIC VOLUME control to MIN by turning it anti-clockwise.
- Connect a microphone (not supplied) by plugging it into the MIC jack.
- Press the DIGITAL ECHO or MPX button on the remote control to select the MPX or Echo mode you want to use.

Each time you press the button, MPX and Echo mode changes as follows.

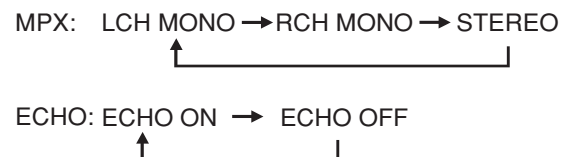

Lch MONO: Only the left channel (instrumental parts) are played through both speakers.

Rch MONO: Only the right channel (vocal parts) are played through both speakers.

STEREO: Normal stereo mode.

- You can also select MPX and Echo mode during playback.
- MPX status is not indicate on the display.
- To return to Normal stereo mode press the MPX button on the remote control until “STEREO” appear on the display.

- Play a multiplex CD.  
To play a video CD with PBC, see page 20.

- Adjust the main volume and the MIC VOLUME control as you sing into the microphone.

- If you want to record on a tape, carry out CD Direct Recording or One Track Recording. (See page 25)

There are three timers available—Daily Timer, Recording Timer, and Sleep Timer. Before using the timers, you need to set the unit’s clock (see page 9).

## Using Daily Timer and Recording Timer

You can set the timer whether the unit is on or off.

### How the timer actually works

When the on-time comes, the unit automatically turns on (the  [timer] and the selected timer mode [DAILY or REC] indicators flash just before the on-time, and continue flashing while the timer is operating). Then, when the off-time comes, the unit automatically turns off (standby).

The timer setting remains in memory until you change it.

- When the DAILY indicator is lit on the display, the timer acts as the Daily Timer. Once the timer has been set, it will be activated at the same time everyday until the timer is turned off.
- When the REC indicator is lit on the display, the timer acts as the Recording Timer. After the timer-recording finishes, the details of the setting remain stored but the timer is turned off.

### Before you start...

- When using “TUNER” as the source to play, make sure to select the desired station before turning off the power.
- There is a time limit in doing the following steps. If the setting is canceled before you finish, start over from step 1.

## 1 Press CLOCK/TIMER.

The  (timer) indicator lights up and the timer mode (DAILY or REC) indicator flashes on the display.

The unit enters on-time setting mode.



## 2 Set the on-time when you want the unit to turn on.

- 1) Press UP or DOWN to set the hour, then press CLOCK/TIMER.
- 2) Press UP or DOWN to set the minute, then press CLOCK/TIMER.

The unit enters off-time setting mode.

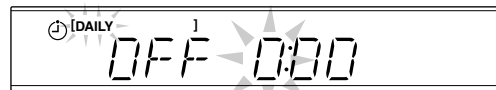
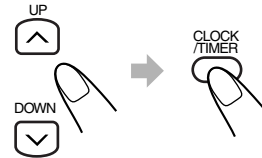

## 3 Set the off-time when you want the unit to turn off (standby).

- 1) Press UP or DOWN to set the hour, then press CLOCK/TIMER.
- 2) Press UP or DOWN to set the minute, then press CLOCK/TIMER.

The unit enters the timer selecting mode.

## 4 Press UP or DOWN to select the timer (Daily Timer or Recording Timer) with the source to play, then press CLOCK/TIMER.

- Each time you press UP or DOWN, the timer mode and the source change as follows:

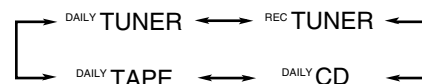

**DAILY TUNER:** tunes in to the last station you were listening to. (Daily Timer)

**REC TUNER:** records the last station you were listening to. (Recording Timer)

- Put a recordable cassette into the deck.

**DAILY CD:** plays a disc. (Daily Timer)

- Load a disc.

**DAILY TAPE:** plays a tape. (Daily Timer)

- Make sure that a tape is in the cassette deck.
- Make sure that the tape direction is correct.

The unit enters the volume level setting mode.



## 5 Press UP or DOWN to set the volume level, then press CLOCK/TIMER.

- You can select the volume level (“VOLUME --” and “VOLUME 0” to “VOLUME 40”).

If you select “VOLUME --,” the volume is set to the previous level when the unit was turned off.

- To turn off the volume while the Recording Timer (REC TUNER) is working, set the volume level “VOLUME 0.”

The unit enters the clock setting mode.

## 6 Adjust the clock if you need.

- See “Setting the Clock” on page 9.

## 7 Press STANDBY/ON to turn off the unit (standby) if you have set the timer with the unit turned on.

- When the timer turns on the unit, the  (timer) and the selected timer mode indicators (DAILY or REC) start flashing.



To deactivate the timer temporarily, press and hold CLOCK/TIMER until the  (timer) indicator on the display goes off.



To activate or change the timer (with the previous setting), follow steps 1 to 7 on pages 28 and 29.

- If you want to change the timer setting after the Daily Timer be used, first deactivate the timer.



- If the unit is turned on when the timer on-time comes**  
Timer does not work.
- When you unplug the AC power cord or if a power failure occurs**  
The timer will be canceled. You need to set the clock first, then the timer again.

## Using Sleep Timer

With the Sleep Timer, you can fall asleep to music. You can set the Sleep Timer when the unit is turned on.

### How the Sleep Timer actually works

The unit automatically turns off after the specified time length passes.

#### On the remote control ONLY:

### 1 Press SLEEP.

The time length until the shut-off time appears and the SLEEP indicator lights up on the display.



- Each time you press the button, the time length changes as follows:

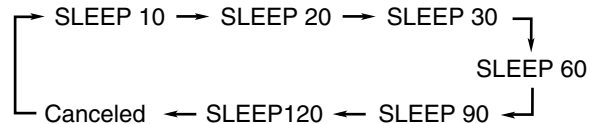

### 2 Wait for about 5 seconds after specifying the time length.

The illumination and display dim.

To check the remaining time until the shut-off time, press SLEEP once so that the remaining time until the shut-off time appears for about 5 seconds.

- The illumination and display brighten during this period.

To change the shut-off time, press SLEEP repeatedly until the desired time length appears on the display.

To cancel the setting, press SLEEP repeatedly until the SLEEP indicator goes off.

- The Sleep Timer is also canceled when you turn off the unit.



- If you set the Sleep Timer after the Daily Timer starts playing the selected source**  
The Daily Timer is canceled. When the Sleep Timer shut-off time comes, the unit will be turned off.
- If you set the Sleep Timer after the Recording Timer starts recording**  
The Recording Timer is canceled, but recording continues until the Sleep Timer shuts off the power.



# Maintenance

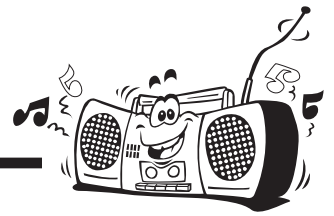

To get the best performance from the unit, keep your discs, tapes, and mechanism clean.

## Cleaning the unit

- **Stains on the unit**

Should be wiped off with a soft cloth. If the unit is heavily stained, wipe it with a cloth soaked in water-diluted neutral detergent and wrung well, then wipe clean with a dry cloth.

- **Since the unit may deteriorate in quality, become damaged or have its paint peel, be careful about the following.**

- DO NOT wipe it with a rough cloth.
- DO NOT wipe it strongly.
- DO NOT wipe it with thinner or benzine.
- DO NOT apply any volatile substances such as insecticides to it.
- DO NOT allow any rubber or plastic to remain in contact with it for a long time.

## Handling cassette tapes

- If the tape is loose in its cassette, take up the slack by inserting a pencil in one of the reels and rotating.
- If the tape is loose, it may get stretched, cut, or caught in the cassette.

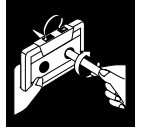

- Be careful not to touch the tape surface.
- Avoid storing tapes in the following places:
  - In dusty places
  - In direct sunlight or heat
  - In moist areas
  - On a TV or speaker
  - Near a magnet

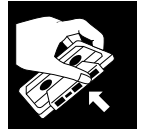

# Troubleshooting



If you are having a problem with your unit, check this list for a possible solution before calling for service.

If you cannot solve the problem from the hints given here, or the unit has been physically damaged, call a qualified person, such as your dealer, for service.

Symptom	Cause	Action
No sound is heard.	<ul style="list-style-type: none"> <li>• Connections are incorrect or loose.</li> <li>• Headphones are connected.</li> </ul>	<ul style="list-style-type: none"> <li>• Check all connections and make corrections. (See pages 6 – 8.)</li> <li>• Disconnect the headphones.</li> </ul>
Hard to listen to broadcasts because of noise.	<ul style="list-style-type: none"> <li>• Antennas are disconnected.</li> <li>• The AM loop antenna is too close to the unit.</li> <li>• The FM antenna is not properly extended and positioned.</li> </ul>	<ul style="list-style-type: none"> <li>• Reconnect the antennas correctly and securely.</li> <li>• Change the position and direction of the AM loop antenna.</li> <li>• Extend the FM antenna to the best position.</li> </ul>
The disc tray does not open or close.	The AC power cord is not plugged in.	Plug the AC power cord.
The disc does not play.	The disc is placed upside down.	Place the disc with the label side up.
The disc sound is discontinuous.	The disc is scratched or dirty.	Clean or replace the disc. (See page 15.)
The cassette holder cannot be opened.	Power from the AC power cord has been cut off while the tape was running.	Plug in the AC power cord, then turn on the unit.
Impossible to record.	Small tabs on the back of the cassette are removed.	Cover the holes with adhesive tape.
Operations are disabled.	The built-in microprocessor may malfunction due to external electrical interference.	Unplug the AC power cord and then plug it back in.
Unable to operate the unit from the remote control.	<ul style="list-style-type: none"> <li>• The path between the remote control and the remote sensor on the unit is blocked.</li> <li>• The batteries are exhausted.</li> </ul>	<ul style="list-style-type: none"> <li>• Remove the obstruction.</li> <li>• Replace the batteries.</li> </ul>

# Specifications

Design and specifications are subject to change without notice.

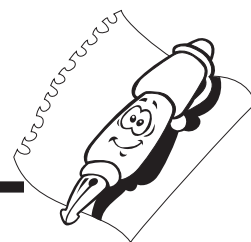

## UX-J66V (CA-UXJ66V and SP-UXJ66V)

### Amplifier

Output Power:

SUBWOOFERS:

90 W (45 W + 45 W) at 6  $\Omega$  (10% THD)

MAIN SPEAKERS:

30 W (15 W + 15 W) at 6  $\Omega$  (10% THD)

Audio input sensitivity/Impedance (at 1 kHz)

AUX: 400 mV/48 k $\Omega$

Speakers/Impedance: 6  $\Omega$  – 16  $\Omega$

### Tuner

FM tuning range: 87.50 MHz – 108.00 MHz

AM tuning range:

AM 10 kHz intervals: 530 kHz – 1 710 kHz

AM 9 kHz intervals: 531 kHz – 1 710 kHz

### CD player

Dynamic range: 85 dB

Signal-to-noise ratio: 90 dB

Wow and flutter: Immeasurable

### Cassette deck

Frequency response:

Normal (type I): 60 Hz – 14 000 Hz

Wow and flutter: 0.15% (WRMS)

### Speaker—SP-UXJ66V

Speaker units: Subwoofer: 13.5 cm cone x 1

Woofers: 8.0 cm cone x 1

Tweeter: 4.0 cm cone x 1

Impedance: Subwoofer: 6  $\Omega$

Main speaker: 6  $\Omega$

Dimensions (approx.):

175 mm x 320 mm x 241 mm (W/H/D)

Mass (approx.): 3.7 kg each

### Supplied Accessories

See page 6.

### General

Power requirement:

AC 110 V/ 127 V/ 220 V/ 230 V – 240 V  $\sim$ , adjustable with the voltage selector, 50 Hz/60 Hz

Power consumption: 135 W (at operation)

3.4 W (on standby)

Dimensions (approx.):

520 mm x 320 mm x 323.3 mm (W/H/D)

Mass (approx.): 12.9 kg

## UX-J55V (CA-UXJ55V and SP-UXJ55V)

### Amplifier

Output Power:

120 W (60 W + 60 W) at 6  $\Omega$  (10% THD)

Audio input sensitivity/Impedance (at 1 kHz)

AUX: 400 mV/48 k $\Omega$

Speakers/Impedance: 6  $\Omega$  – 16  $\Omega$

### Tuner

FM tuning range: 87.50 MHz – 108.00 MHz

AM tuning range:

AM 10 kHz intervals: 530 kHz – 1 710 kHz

AM 9 kHz intervals: 531 kHz – 1 710 kHz

### CD player

Dynamic range: 85 dB

Signal-to-noise ratio: 90 dB

Wow and flutter: Immeasurable

### Cassette deck

Frequency response:

Normal (type I): 60 Hz – 14 000 Hz

Wow and flutter: 0.15% (WRMS)

### Speaker—SP-UXJ55V

Speaker units: Woofer: 12.0 cm cone x 1

Midrange: 4.0 cm cone x 1

Tweeter: 2.0 cm dome x 1

Impedance: 6  $\Omega$

Dimensions (approx.):

160 mm x 285 mm x 181.5 mm (W/H/D)

Mass (approx.): 2.4 kg each

### Supplied Accessories

See page 6.

### General

Power requirement:

AC 110 V/ 127 V/ 220 V/ 230 V – 240 V  $\sim$ , adjustable with the voltage selector, 50 Hz/60 Hz

Power consumption: 130 W (at operation)

3.4 W (on standby)

Dimensions (approx.):

490 mm x 286 mm x 323.3 mm (W/H/D)

Mass (approx.): 10.3 kg

## Mains (AC) Line Instruction (not applicable for Europe, U.S.A., Canada, Australia, and U.K.)

主 (AC) 电源线路说明 (不适用于欧洲、美国、加拿大、澳洲及英国型号)

คำแนะนำเกี่ยวกับสายไฟหลัก (AC) (ยกเว้นประเทศในยุโรป สหรัฐอเมริกา แคนาดา ออสเตรเลีย และสหราชอาณาจักร)

### VOLTAGE SELECTOR

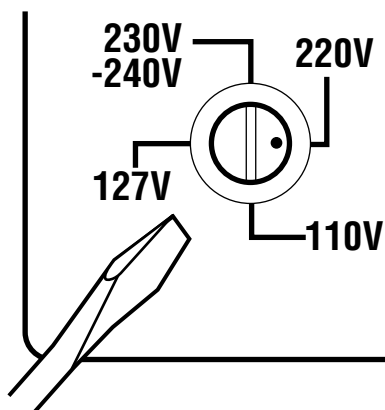

#### IMPORTANT for mains (AC) line

BEFORE PLUGGING IN, do check that your mains (AC) line voltage corresponds with the position of the voltage selector switch provided on the outside of this equipment and, if different, reset the voltage selector switch, to prevent from a damage or risk of fire/electric shock.

#### 有关主 (AC) 电源线路的重要事项

接插电源以前，务请检查当地的主(AC)电源线路电压是否和位于本机外面的电压选择开关设定的位置一致。如果不一致，即重新设定电压选择开关使符合当地电压，以免损坏机器或引起火灾/触电的危险。

#### สิ่งสำคัญเกี่ยวกับสายไฟหลัก (AC)

ก่อนเสียบปลั๊ก ให้ตรวจสอบแรงดันไฟฟ้าของสายไฟหลัก (AC) ของท่านว่าเท่ากับกับตำแหน่งของสวิตช์เลือกแรงดันไฟฟ้าที่อยู่บนอุปกรณ์หรือไม่ หากแรงดันไฟฟ้าไม่เท่ากัน ให้ตั้งสวิตช์ใหม่เพื่อป้องกันความเสียหายและเสี่ยงการเกิดไฟไหม้/ไฟดูด

